

UNICOL[®]

Edition 57



Mounting
Solutions

Supporting You

Welcome to the 2020 UNICOL Catalogue

Our comprehensive range of AV equipment mounts is available ex stock and offers unrivalled flexibility. Order either as standard assemblies or in component form to suit your own requirements. We also offer an efficient service in the manufacture of custom made items, from 'one-off' specials to large scale projects for corporate users. – Call us today or visit our website!



2020 and our new decade is both a journey into the unknown and an opportunity to embrace new technologies, so uncharted as well as exciting times lie ahead.

What is certain is the growing and urgent need to respect our planet and conserve all those precious resources once casually thought of as infinite. All of us are being called upon to play our part, and manufacturers such as ourselves particularly so given the many hundreds of tonnes of products that leave our factory annually. Unicol is perhaps fortunate in that the steel and aluminium it uses is all recyclable and the cardboard packaging also. What little in the way of plastics used are all clean and identifiable so again fully recyclable. One of the virtues of manufacturing everything in the UK as we have done over the last 56 years is that our products are not shipped from places afar such as China or the USA thus further reducing our carbon footprint. Finally, with so many of our products being designed as modular interchangeable parts, long term re-usability is another positive aspect.

This latest addition of our catalogue includes many new products and upgrades to others. Our website offers a parallel reference enabling easy access to products listed using alternative search options. We look forward to working with new and existing loyal customers, supplying both standard products, custom made items and being involved with the more complex projects which our design and manufacturing teams routinely do.



UNICOL products have been designed to meet BSI installation specification standard BS8590. All goods are sold subject to the Companies terms & conditions of sale, a copy of which is available upon request or can be downloaded from our website www.unicol.com. VAT will be charged at the prevailing rate at time of invoice. Mechanical items have a 10 year design & manufacturing warranty. Electrical parts are covered by a 12 month return to base warranty. UNICOL products are the subject of continuous development and we reserve the right to improve designs or change specifications without prior notice.

Products and prices listed in this catalogue are correct at time of going to press (Issue 57 - 2020). © Peter Ligertwood 2020.

UNICOL Engineering, Green Road, Oxford, OX3 8EU, England

Contents – Product Finder Pages

	What's New Special Projects 4 & 5		Screen Mount Trade Packs Slim Profile Mounts 24 & 25
	VS1000 Stands, Trolleys & Components 6 & 7		Wall Arms Panarm & Standard Range 26 & 27
	Axia Stands & Trolleys 8 & 9		Outdoor Housings & Covers 28 & 29
	Avecta Stands Parabella & Tevella 10 & 11		Indoor Kiosks & Totems 30 & 31
	Rhobus Stands & Trolleys Nesting Trolley 12 & 13		Video Wall Mounts V-Wall Video Wall Stand AV Roller Trak 32 & 33
	Large Axia Titan Stands & Trolleys Motorised Stands 14 & 15		Screen Rail Gantry Systems 34 & 35
	AV Furniture Huddle Tables Education Lecterns 16 & 17		Floor to Wall & Ceiling Cassette Mounts PC Housings 36 & 37
	AV Teaching Lecterns Cabinets & Large Screen Lecterns 18 & 19		PSU Projector Units Guardbox Security Cages 38 & 39
	Dedicated Wall Mounts Sound & Video Bars Universal Wall Mounts 20 & 21		Gyrolock Projector Mounts 40 & 41
	Installation Components 22 & 23		Single Column Stands & Trolleys Parts & Accessories 42 & 43

new

NEW PRODUCTS FOR 2020



How To Order

Call our technical sales team direct, via email or order online. We are more than pleased to help regarding best choice of items to order or advise on any project being considered.

Tel: 01865 767676
Email: sales@unicol.com
Web: www.unicol.com

Most standard products are available on an ex stock basis. Please state screen or projector make / model & colour choice.

Symbols & other information



Typical single screen guide: Light or heavy monitors will influence this.



Maximum carrying capacity for which each product is designed.



Colours ex stock. (no cost where shown)
 Sinterflex black (standard)
 Diamond silver / white (optional)

Please state colour choice when ordering (Non-standard colours to special order)

Dimensions shown are metric
 Prices shown are Ex Works, Ex VAT

UNICOL Special Projects Department

Highlighting our in-house design & manufacturing capabilities, resolving every day customer requests.

CORPORATE

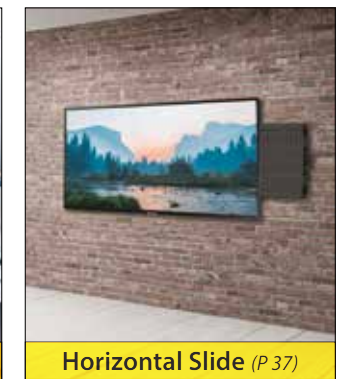
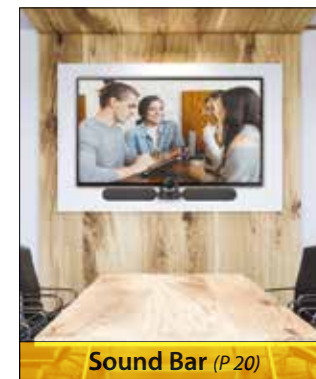

TRAVEL

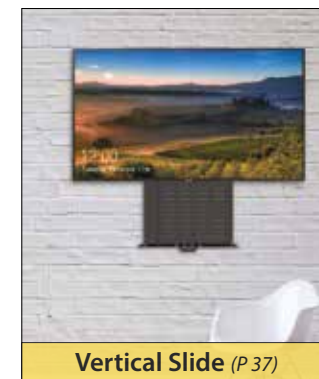

EDUCATION



RETAIL

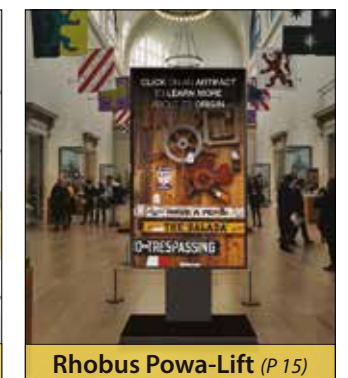



"The Work Horse of the AV industry"

With a wide choice of interchangeable parts, easy assembly and sheer robustness VS1000 trolleys are the favoured choice of trade show, education, broadcast and AV users everywhere.

Available as static, wheeled base or back to back versions, with a wide choice of height options. Accessories include metal or glass shelves, locking cabinets and other options.



Height to centre of screen 1500mm

60kg MAX
Typically 33-70" screens

Standard VS1000 trolley with classic 'K' base

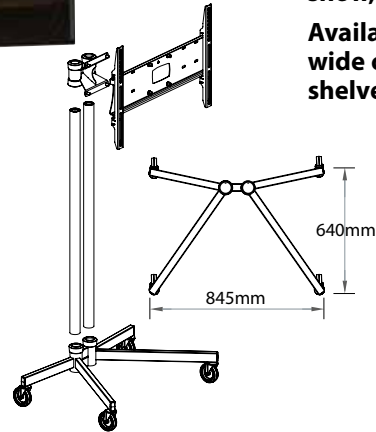

Heavy duty braked wheel options - see Page 43.

Standard 'K' base trolleys

With VESA Screen Mount

Order Code
VSB-1500x2-VMSV
100 x 200 & 200 x 200 VESA - up to 32" / 35kg max
VSB-1500x2-VMSV2
300 x 300 & 400 x 400 VESA - up to 40" / 40kg max

With Universal Screen Mount

Order Code
VSB-1500x2-PS2-PZX
For screens up to 70" - up to 60kg max
(State screen make & model)



Stand for single display on plinth base (shelf optional)

VSL-1500x2-PS2-VP1-PZX



Scimitar base with optional locking cabinet

VSS-1500x2-PS2-VLC-PZX



Single display on bolt down base

VSF-1500x2-PS2-PZX



Portrait back-to-back display on plinth base

VSLBB-1500x2-PS8-PPZXx2

Build any configuration from the components listed below

Choose from the standard units listed or select & assemble any of the parts to suit your needs

VS1000 trolleys with Scimitar bases

The curved design of the Scimitar base units offers an attractive alternative to 'K' base versions.

Whichever style you choose all these trolley assemblies are available in both VESA or Universal screen mount versions.



Height to centre of screen 1500mm

60kg MAX
Typically 33-70" screens

Standard VS1000 trolley with Scimitar base

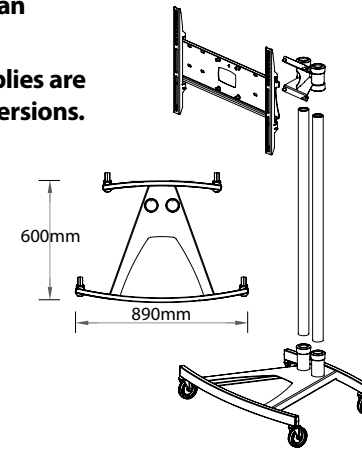

Heavy duty braked wheel options - see Page 43.

Standard Scimitar base trolleys

With VESA Screen Mount

Order Code
VSS-1500x2-VMSV
100 x 200 & 200 x 200 VESA - up to 32" / 35kg max
VSS-1500x2-VMSV2
300 x 300 & 400 x 400 VESA - up to 40" / 40kg max

With Universal Screen Mount

Order Code
VSS-1500x2-PS2-PZX
For screens up to 70" - up to 60kg max
(State screen make & model)



Mount Adapters

Converts Pozimount mounts (or Xactmatch mounts) to fit twin columns. Standard Allen screw fixing. Fully height adjustable.

Order Code
PS2 Standard single screen
PS8 Back to back screens

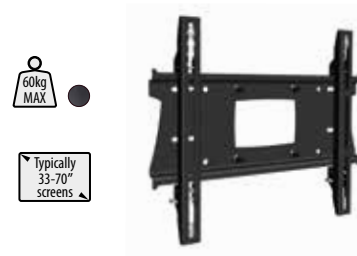

Pozimount Universal Flat Screen Mount

For screens 42" to 70" plus VESA fixings 200 x 200 to 400 x 400.

Order Code
PZX3 non-tilting
Full Pozimount range on Page 21



Column fitting VESA Mount

Fits direct to columns, covers many popular VESA screen mount sizes.

Order Code VESA fixing mm
VMSV 75 x 75, 100 x 100, 100 x 200 & 200 x 200
VMSV2 300 x 300, 400 x 200 & 400 x 400



Shelves

In metal or toughened glass.

Order Code metal / mm
VP1 500w x 400d
VP2 550w x 450d
VP3 300w x 300d
Order Code glass / mm
VGS 500w x 400d



Scimitar™ Bases

Elegant curved design. Trolley base has 10cm non marking rubber tyre wheels.

Stand version has 1.5cm plastic feet.

Order Code mm
VSS 870w x 600d
VSR with BRAKED wheels
VSX Stand version (without wheels)

VSR base has higher spec BRAKED wheels - supports up to 105 Kg



Standard Plinth Base

Stylish plinth base has resilient non-marking feet. Has clearance for cables routed beneath.

Order Code mm
VSL 760w x 580d



Columns

Chrome plate finish (pair)

Order Code Length mm
1500X2 1500

Brushed Stainless Steel (each)

Order Code Length mm
1500SS 1500

(Other column lengths listed on Page 22)



Locking Cabinet

For DVD players, PCs etc. Fully height adjustable. Rear panel has access for cables.

Order Code Internal Dimensions mm
VLC 550w x 150h x 400d



Original 'K' Base

Still preferred by many for its robust design. Has 10cm non-marking rubber tyre wheels.

Order Code mm
VSB 845w x 640d
VBR with BRAKED wheels

VBR base has higher spec BRAKED wheels - supports up to 105 Kg



Back-to-Back Base

With centralised column sockets for Back-to-Back screen use. Resilient non marking feet & clearance for cables routed beneath.

Order Code mm
VSLBB 700w x 700d



Compact Bolt Down Base

Offers minimal base footprint for fixed screen stands. M10 floor bolts (not supplied) fully recess into base. Trim caps neatly complete installation.

Distance from twin sockets to base rear edge - 25mm
Order Code mm
VSF 400w x 300d



4-Way Power Sockets

These clip to the base of the VS1000, TC1000 and the Single Column Trolley range (Page 42). With 4m cable and 13A plug. European version also listed.

Order Code
ESU UK as illustrated
ESE Europlug



- * Graceful, stylish design
- * Neat cable management
- * Screen mount included
- * 4-way power socket
- * Safety glass shelves
- * Video Conference versions
- * Portrait screen options
- * Corporate colour options



Height to centre of screen 1500mm

Standard Axia Hi-level stand

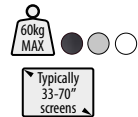

Standard Axia Lo-level stand

Height to centre of screen 1200mm

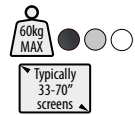

Hi-Level Stands

With our PZX universal screen mount. Stylish plinth base has resilient non-marking feet. 4-way power socket neatly locates behind screen.

Select toughened glass or metal shelves as required.

Standard Hi-Level Stand

Order Code **AX15P** for screens up to 70"

Lo-Level Stands

The quality option for corporate lounges or hospitality seating areas.

With our PZX universal screen mount. Plinth base has resilient non-marking feet. 4-way power socket neatly locates behind screen.

Standard Lo-Level Stand

Order Code **AX12P** for screens up to 70"



Hi-level Stand with AXLC Locking Cabinet

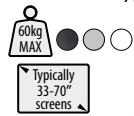

Hi-level Plinth Cabinet

Height to centre of screen 1650mm



Plinth Cabinet Stand

Popular for showroom or exhibition use. Lockable base for PCs, DVDs etc has resilient non-marking feet.

Order Code **AX16P** Cabinet Base version
Cabinet internal dims 480(w) x 400(d) x 160(h)mm



Height to centre of screen 1600mm



Standard Axia Twin screen trolley version Sinterflex Black



Height to centre of screen 1200mm

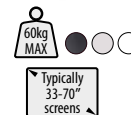

Lo-level trolley in optional silver

Axia Twin Screen and Video Conference Stands & Trolleys

These internally strengthened units for twin screen use cover a wide range of screen sizes. Easy to set up, using our PZX universal screen mounts. Toughened glass shelf is included.

Order Code **AXC15P51** Stand Versions screens 38" - 57"

Order Code **AXC15T51** Trolley Versions screens 38" - 57"

State make & model of screens when ordering Above screen video conference mounts and larger screen versions also available.

- Call us for any advice or assistance required



Standard Axia Hi-level trolley in optional Diamond Silver

Height to centre of screen 1600mm

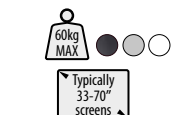

Heavy duty braked wheel options - see page 43.

Lo-Level Trolleys

Includes PZX universal screen mount, 7.5cm twin wheel castors. 4-way power socket neatly locates behind screen.

Standard Lo-Level Trolley

Order Code **AX12T** for screens up to 70"

Hi-Level Trolleys

Uses PZX universal screen mount and base with 7.5cm twin wheel castors. 4-way power socket neatly locates behind screen.

Select toughened glass or metal shelves as required.

Standard Hi-Level Trolley

Order Code **AX15T** for screens up to 70"

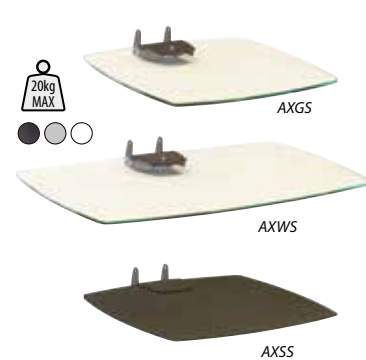

Shelves

Edge polished toughened glass or metal versions available.

Lugs fit through mast slots & screw securely into position.

Order Code *glass / mm*
AXGS 500w x 400d
AXWS 780w x 390d

Order Code *metal / mm*
AXSS 500w x 400d

Axia Locking Cabinet

For DVD players, PCs etc.

Lockable drop down door.

Rear panel has access for mains and other cables.



Order Code *Internal Dimensions mm*
AXLC Size 550w x 150h x 400d

Video Conference Mount

For most makes/models of cameras. Fits either above or below screen.

Telescopic adjustment enables camera platform to be positioned at optimum height.

Dedicated mounts for specific makes/models of cameras also available - Call us for details.

Order Code *mm*
VCM shelf size 340w x 260d

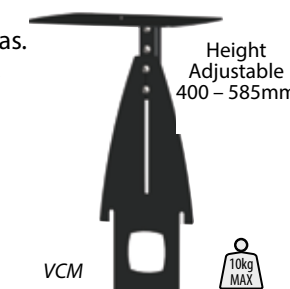

Height Adjustable 400 - 585mm



Axia Colour Options

With their graceful flowing curves Axia stands & trolleys already look good in their standard finishes.

Adding a corporate or individually chosen colour can dramatically enhance the effect, harmonise with interior schemes or even the screen itself.

- Call us for further details



Avecta Stands & Trolleys



From boardroom to show venue – a flexible and adaptable stand system with excellent cable management. Static or wheeled versions, single or dual screen options.

Hi-Level Stand & Trolley

Height to centre of screen adjustable from 1100mm to 1500mm complete with PZX universal screen mount, 4-way power socket and all metal shelf.

Order Code

AVHP Stand with universal mount

AVHT Trolley with universal mount

AVHTR1 With RTM10 Rotamount complete

AVHTSURH Trolley for MS Hub 2 with shelf

AVHB Stand with bolt down base & shelf



AVHTSURH with MS Hub 2 shown tilted & shelf folded

Height to centre of screen 1250 to 1520mm

Lo-Level Stand

Height to centre of screen fully adjustable. Comes with PZX universal screen mount, 4-way power socket and all metal shelf.

Order Code

AVLP

Height to centre of screen 600 to 950mm



Avecta AVLP

Typically 33-70" screens

new



Avecta AVHP with optional 2 x AVGS glass shelves

Typically 33-70" screens

Bolt-Down

Floor to wall also available.

Heavy Duty Trolley

For large screens up to 110" – this trolley comes with an integral universal mount. Height to centre of screen adjustable up to 1500mm.

State screen make & model when ordering

Order Code **TCAVT**

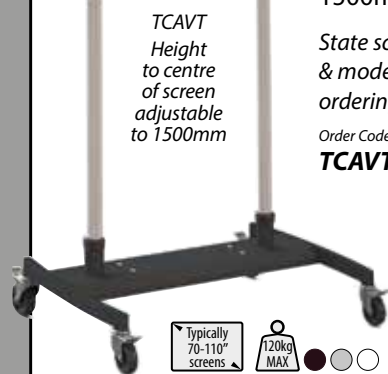

TCAVT Height to centre of screen adjustable to 1500mm

Typically 70-110" screens

Video conference & twin screen units

Different screen sizes can be accommodated using one of 3 central cross member types which carry our standard Pozimount universal mounts.

Comes with metal shelf. Order video conference camera mount, or glass shelf as required.

Order Code

ACHT Hi-level Trolley

ACHP Hi-level Stand

State screen make & model when ordering



Avecta ACHT with AVP1 metal shelf and optional VCM video conference mount

VCM Video Conference Mount also available – (See Page 21)

Typically 33-57" screens

35kg MAX per screen

Avecta Accessories

Equipment Shelves

Height adjustable. Cable entry.

Order Code	Type	mm
AVGS	Glass	500w x 400d
AVP1	Metal	500w x 400d
AVP2	Metal	550w x 450d
AVP3	Metal	300w x 300d
AVP4	Folding	440w x 350d

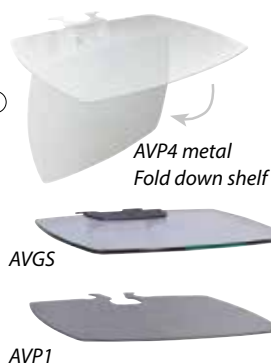

AVP4 metal Fold down shelf



AVGS

AVP1



Curva Trolley Base

Stylish, compact alternative to standard base. ●●●

Order Code **AVTR**



Locking Cabinet

Height adjustable. Door conceals into roof. Has usable top surface.

Order Code inside dimensions mm **AVLC** 500w x 140h x 400d

Popular & Specialist Stands



The recommended stand unit for exhibitions & conferences.

- * Curved slim design
- * For screens 40 - 80 inch
- * Neat cable management
- * 1.8m viewing height
- * Standard & Large available

Standard Parabella

Comes with PZW1 universal mount & converter.

Order Code

PA2 for screens 40" - 70"

Heavy Duty Parabella

Comes with PZX9 universal mount, larger base & converter.

Order Code

PA9 for screens 71" - 80"

Note: Parabella is not suitable for touch screen use.

Parabella Accessories

Glass Shelf

Toughened glass fully edge polished.

Order Code

PARAG2S size 500w x 400d



20kg MAX



State screen make & model when ordering

Typically 40-80" screens

80kg MAX



Base & Converter – screens up to 80"

Order Code

PARAB2 large size 1210w x 700d

CTPA3 mount converter

Power Sockets

In special housing to fit Parabella stand with 4.5m cord.

Order Code

PARAES4B 4-way socket



Tevella TV Stand

- * Cables routed through base & column
- * Bolt down version also available
- * Stand height to centre of screen 100cm
- * Trolley height to centre of screen 140cm

Order Code

TVV1 Upright - 15-32" screens

TVL1 Lectern Version - 15-32" screens

Trolley Version - 15-40" screens

Order Code

TVB1 Bolt Down Version - 15-40" screens



TVT1

Typically 15-40" screens



TVL1

TVV1

Typically 15-32" screens

15kg MAX

RHOBUS Video Conference & Presentation Range

RHOBUS®

The complete corporate communications platform ...



- * Premium boardroom quality
- * Sinterflex black or white as standard
- * Wide choice of screen options
- * Discreet cable management

- * Powalift operated options
- * Lockable housing for codec etc
- * Supplied with castors & static feet
- * Single box solution

With its clean lines and superior finish options the Rhobus range of stands and trolleys answers all the needs of the corporate user – from boardroom to prestige exhibitor.

Choose from the elegant single screen version through to multi-screen units to support the very latest and best in corporate communications. Ample capacity is provided within the central mast for cabling, codecs and other systems, all accessible through a locking door. Built in power socket comes as standard.

Rhobus Models	
Order Code	
RH100	Single Screen (33" - 70")
RHBD100	Bolt Down (33" - 70")
RH200	Twin Screen (33" - 70")
RH100HD	Heavy Duty (71" - 110")
RFWSHHD	Floor to Wall (71" - 110")
RHPL100HD	HD Powalift (71" - 110")
RH400HD	2 x 2 Screen (33" - 57")
Bases	
Order Code	
RHB1	Standard Base – 900(w) x 500(d)
RHB2	Heavy Duty Base – 1200(w) x 660(d)
RHUBD	Bolt Down / Floor to Wall – 650(w) x 310(d)
NSTB1	Nest-Star Trolley Base – 1115(w) x 770(d)

new

Rhobus Accessories	
Order Code	
RHGS1	Glass Shelf – 500(w) x 400(d)
RHGS2	Glass Shelf – 780(w) x 390(d)
RHCB1	Blade style Camera Mount
RHCC	Blade mount conversion shelf
RHH1P	Manoeuvring handles
VCM	Standard Camera Mount
RFWSWT	Wall Tie (attaches mast to wall)
Masts	
Order Code	
RHMU1	Standard Rhobus & Nestar Mast
RHMU2	Rhobus Power Lift Mast
RHMU3	Rhobus Floor to Wall Mast
	Taller Masts can be made to order Please call us for details



Rhobus RH200 Trolley in non-standard RAL 7035 light grey with twin screens, blade camera mount & centre infill panel

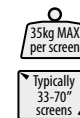

Height to centre of screen 1400mm

Fully adjustable screen arms RHPZX1VW, RHPZX3VW & RHPZX5VW are used on twin screen units

RHOBUS Accessories

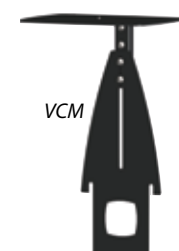

Camera Mount



Glass Shelf



RHCB1 Blade style camera mount



RHCC Blade mount conversion shelf

* Our RHCC conversion shelf is also available in versions dedicated to specific cameras. Above screen camera mounts also available.

An abundance of practical features



Easy swap from twin wheel castors to static feet to suit your needs



Easy access to mast housing – dims 440(w) x 470(h) x 80(d) via lockable pull down door



Rhobus RFWSHHD Floor to Wall stand with front panel lockable access door & a power socket in either side, in Sinterflex black

Camera mounts available in two versions: (See P21)

- * VCM standard mount fits above or below screen
- * Vertical blade type allows camera to be positioned between screens.

NEST-STAR® Nesting Trolleys

A complete teaching assistant on wheels that can be deployed quickly and neatly stowed when not in use.

This robust trolley supports your displays and securely houses your favourite PCs and controllers. The standard trolley comes with a plain mast. However, we understand that choice of equipment is important and will customise the rear or front of the mast section with a 300 x 300 x 100mm cable/keypad pocket and standard double gang wall plate & cable assembly at an additional cost. (Please call us for a quote). Handles are provided for ease of movement as standard.

These trolleys can quickly turn an empty space into an effective student e-learning environment. Whilst Sinterflex Black is the standard colour, other bright & bold finishes are available.

- * Robust modular construction
- * Easy to assemble and install
- * Quick and easy deployment
- * Customisation available
- * Secure storage for players / PCs
- * Standard black with colour options
- * Fast turnaround delivery 5 - 7 days

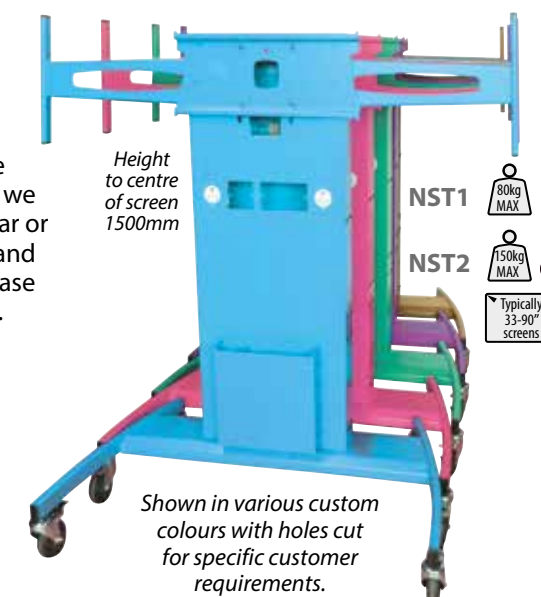
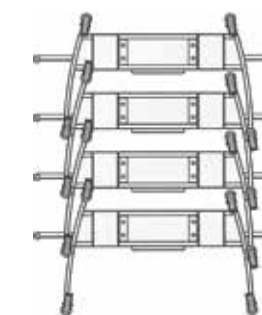

Height to centre of screen 1500mm

NST1 80kg MAX

NST2 150kg MAX

Typically 33-90" screens

* Please Note: Standard trolley comes in Sinterflex Black with plain mast. The rear / front of the mast can be customised with a cable/keypad pocket and double gang wall plate & cable assembly.

When ordering please state make & model of screen, custom option requirement and colour choice. There will be an additional charge of 18% for non-standard colours.

Axia Titan

Designed for large format or multi-screen applications, these trolleys incorporate heavier mast sections and increased base footprint to accommodate large screen sizes and heavier loads. Axia Titan trolleys come in 4 versions:

- * Fixed Height
- * Manual Easy Lift
- * Bolt Down versions
- * PowaLift with Remote

Safety Note: Safety must always be the first priority when handling large / heavy screens, which should be installed by qualified personnel using appropriate lifting equipment. Manoeuvre and position trolleys only on flat and even surfaces. Large screens may need removing when manoeuvring trolley under standard door heights.

Manual Easy Lift

Smooth 'ratchet action' for easy lifting. Practical, reliable and immune from show venue power outages!



Manual Easy Lift Trolley For Screens up to 98"

Order Code
AXW20 1.5m to 2.5m centre of screen

PowaLift Electronic

Axia Titan PowaLift Versions. – Smooth powered vertical travel for screens up to 110"

These trolleys incorporate a powerful linear drive system within the heavy duty mast. Supplied with hand held remote and manual switch option as standard.

Order Code
AXL15T2J for screens up to 110"

CE approved & DDA compliant

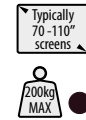
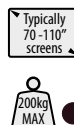

Fixed Height
2m Trolley
Version

Fixed Height

For Screens up to 110"

Order Code
AX15T2J 1.5m to centre of screen
AX20T2J 2m to centre of screen

For multiple 2 x 2 (4) Screens
Up to 55" & 35kg max per screen

Order Code
AXM20T31 2m to centre of screen

State make & model of screen



Shown on plinth base supporting 4 x 55" screens



PowaLift™

Electronic control & PowaLift technology combine in these versatile units.

- * Safe, smooth operation
- * Well proven technology
- * Quality, long life components
- * For screens 33 to 98 inch
- * Controllable by remote fob, cord switch or direct from your laptop – all supplied with unit

Operated by wireless remote or manual switch, screens can be commanded to rise or descend smoothly through 700mm, stopping safely at any point.

These units serve many requirements, particularly in the field of education, enabling young children or wheel chair users to interact with touch screens. 'Touch of a button' height control also makes it easy to move from one location to another through doorways.

Screen mount, hand held remote with manual switch and 4-way power socket supplied as standard.



AVMT71

Trolley Version

Order Code
AVMT71 33" to 70"

State make & model of screen

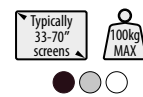

Rear of unit shown with 4-way power socket, antenna, power-in, USB & cord switch socket



Laptop Arm fully extends & articulates

Laptop platform

Order Code
AVML7



CE approved & DDA compliant

AVMW71

Floor to Wall Version

Using the same proven mast technology as our trolley version these units allow fixed installation with the benefit of compactness and slim profile.

Order Code Standard
AVMW71 33" to 70"

Order Code Heavy Duty
AVMW91 71" to 98"

State make & model of screen



RHOBUS PowaLift

Rhobus RHPL100HD Trolley with 'Touch of a button' PowaLift technology to raise and lower screens smoothly through 700mm.

For larger screens the Rhobus Powalift version has all the functionality of the original - above.

- * For screens 71 to 110 inch
- * Safe, smooth operation
- * Quality, long life components
- * Bolt down & Floor to Wall versions available
- * Controlled by remote fob, cord switch or direct from your laptop – all supplied with unit

Order Code
RHPL100HD HD Powalift (71" - 110")



RHOBUS
Huddle



There are two Rhobus table versions, Huddle and Stand-to-Meet. The Huddle can be powered up and down to adjust table height. Both have ample capacity & connectivity for cabling, codec and integration with other systems, all accessible through a cable well and locking door. Built in 4-way power socket comes as standard.

Video conference camera mounts are available for all the leading manufacturers of VC equipment. Table tops can be customised in different shapes with cut-outs for all the leading brands of connectivity devices. They can also be branded with different colours and logos. Seating can be supplied as an optional extra.

- * Full unified connectivity
- * Underside rack options
- * Built in hearing induction loop
- * Motorised height adjustable top
- * Branding, logos & special finishes
- * Accommodates wide choice of devices
- * Lockable equipment housing
- * Fast turnaround

Order Code
RHO1
RHO2

Rhobus Huddle

Single Screen version
Twin Screen version

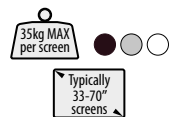

RHOBUS
Stand-to-Meet



Rhobus Stand-to-Meet

Order Code
RS01 Twin screen stand to meet unit
RSU01 Underside custom controller /switcher unit
RSU02 Large front mast for cable cubby with retractors

AVplates
getting you connected

As a distributor of AV Plates we can enhance any models of Unicol AV Furniture - Please call for details.

Canterbury™

Free Standing Lectern

- * Premium lecture room quality
- * Fast turnaround
- * Customised control housing options
- * Secure front & rear installation access
- * Lockable, with key alike options
- * Concealed castors plus levelling feet
- * High quality monitor arm included
- * Sinterflex Black & other colours available
- * 19inch, 16U rack supplied as standard
- * Quality wood finish 36mm work surface
- * All to BS8590 AV Code of Practice guidelines



Versatile lectern provides secure storage for media electronics with 19" 16U rack mounting as standard. Stylish oval cabinet has concealed castors with jacking feet for extra stability on uneven surfaces. The range of durable desk tops are available in a choice of sizes and incorporate a control panel housing for standard & custom apertures together with power outlets.

High quality monitor arm is fully adjustable, desk top has generous room for keyboard and visualiser (if required). All are available in 1000, 1250 & 1500mm widths, 750mm deep with a choice of wood effect finishes. In addition to the standard units offered we are able to customise for a wide range of requirements plus colour options and branding. This premium self contained lectern is complimentary to any modern lecture theatre.

Desk Top and Cabinet Choices:

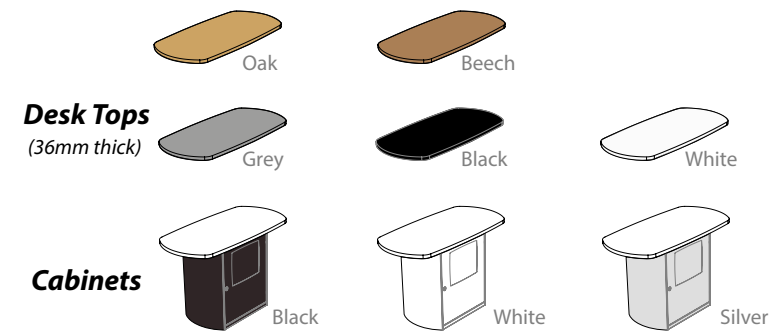

How to Order

Choose from the three models listed below and select any of the desk top & cabinet finishes listed. Please include preference for monitor arm left or right and control panel housing requirements.

Order Code
UFCL10 **Canterbury Lectern**
Top - 1000x750x36mm - with Monitor Arm & Control Housing
UFCL12 **Canterbury Lectern Plus**
Top - 1250x750x36mm - with Monitor Arm & Control Housing
UFCL15 **Canterbury Lectern Pro Plus**
Top - 1500x750x36mm - with Monitor Arm & Control Housing

Presentor™

Wall Mounted Control Desk

Ideal for small lecture theatres or anywhere where space is limited. Folding work surface is ideal for laptop, notes etc. Unit is designed to be functional yet compact, with many control panel options.

Lockable cabinet (with key alike options) is provided for a PC with access to PC ports and power through the side of the unit. A 3U rack strip is also built in. Options include standard UK two gang aperture, plus any other control panel features required.

How to Order

Decide control panel preferences and PC or other items to be housed. Our technical team will be pleased to advise regarding options available. In addition to colour choice offered, alternative finishes can be quoted for.

Order Code **UFPL08** mm
800(w) x 796(h) x 605(d)

Work Surface **Cabinets** white black



The Principal™ Lecturer's Desk

Provides lecturer's with a central desk facility to control AV lecture content, screen or projector video sources, audio, lighting levels and more. Cabinets have 19" removable 6U racks. The desk, with control housing and screen mount, powers up and down for standing or seated operation using the manual switch or remote fob supplied.

- * 19" removable 12U racks allows pre-installation option
- * Full cable management allows for bulky connectors
- * Motorised Desk Top in a range of widths & finishes
- * Screen mount has left/right or multi-screen options
- * Control Housing has standard & custom apertures
- * Quick release doors for ease of installation
- * Generous desk top space for visualiser if required
- * Castor mobile for access through standard doorways
- * Optional custom logos plus illuminated versions
- * Fast turnaround



Shown with desk top raised, fully equipped control panel with phone, monitor, microphone, visualiser, keyboard and custom illuminated logo

Desk Top and Cabinet Choices:

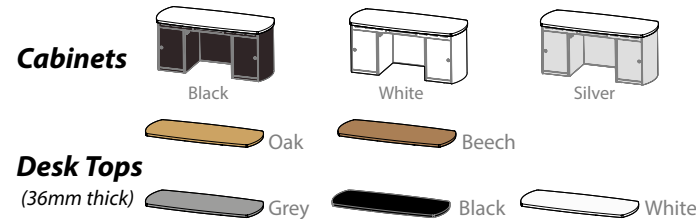

How to Order

Choose from the three models listed below and select any of the desk top & cabinet finishes listed. Please include preference for monitor arm left or right and control panel housing requirements.

Order Code	mm
UFPD15	1550(w) x 778(h) x 700(d)
UFPD18	1850(w) x 778(h) x 700(d)
UFPD24	2400(w) x 778(h) x 700(d)

The Mentor™ Lecturer's Desk

With the ability to change lighting, content, audio and video sources from one place, the Mentor allows users to take control in any lecture theatre from one desk facility.

How to Order

Select any of the desk top & cabinet finishes listed above. Please include preference for monitor arm left or right and control panel housing requirements.

Order Code	mm
UFMD13	1300(w) x 778(h) x 700(d)

- * Hinged desktop gives easy access to AV equipment beneath
- * 19" removable 12U racks with additional 1U vertical rack featured in desk leg
- * Full cable management
- * Lockable, with key alike options
- * Concealed castors plus levelling feet
- * Neat quick release door mechanism
- * Desk top control housing options
- * Range of desktop and cabinet finishes
- * Custom illuminated branding options



Table Stands for screens 40 – 70 inches

Our table stands are available in Universal & Dedicated mount versions: Standard VESA sizes are covered by our PFT1, 3 & 21 stands. Larger screens – 58" and above are covered by our dedicated model range designed and manufactured for each make & model listed.

All versions have resilient non marking feet.

Order Code	mm
PFT3	Universal 32" to 57" – 200 x 200 to 400 x 400 VESA
PFT1	Universal 40" to 57" – 200 x 200 to 600 x 400 VESA
PFT21	Universal 58" to 70" – 200 x 200 to 600 x 400 VESA
PFL3	Dedicated 71" to 90" – max weight 60kg

State screen make & model when ordering



Illustration shows 70 inch screen version from our dedicated model range

Typically 58-70" screens

60kg MAX

19" Rack Cabinet & Screen Units

This versatile range provides secure storage for media electronics. 19" rack mounting as standard, shelves optional. Select mast & screen mount units from the listings below.



AVR5 - M1X1 Media Screen Unit

Typically 33-57" screens
40kg MAX



AVR5 Standard cabinet 500w x 700h x 500d

Order Code	mm
AVR5	Standard rack mount depth 442mm
AVR7	Extended rack mount depth 642mm
AVR9	Oval style cabinet (dims as standard)

Mast assembly inc single screen mount



AVRHD3 Dual heavy duty display, triple cabinet credenza. Columns, screen mounts & 3 x 12u racks included

Order Code	mm
AVRT5	Standard rack mount depth 442mm
AVRT7	Extended rack mount depth 642mm
M2X1	Mast assembly inc twin screen mount

Order Code	mm
AVRHD3	inc. columns, mounts & 3x12u racks

* Special Non-standard Versions of these cabinets, screen mounts and accessories are also manufactured – Call us for details.



AVRT5 Standard twin cabinet 1015w x 700h x 500d

Universal Shelves

Fit all cabinet versions and locate into rack mount slots. Useful above / below rack mounted equipment or in any way required.

Order Code	mm
VR300	1u Rack
VR500	Shelf – 430mm(d)
VR700	Shelf – 630mm(d)

TABLEAU Large Screen Lecterns



Height to centre of screen 1000mm

80kg MAX
Typically 33-70" screens

TABLEAU

Mast incorporates two compartments, both 344(w) x 95(d) – 1 x 280(h) & 1 x 398 (h), to house small PCs or other electronics together with cabling. Base unit has resilient non marking feet and clearance for cables routed beneath.

Order Code	mm
TL1-PZ1	for screens 33" - 70"

State screen make & model when ordering

TABLEAU+™



0 to 90° Tilt

TL2

Smooth Powered Operation

There are two models offered: Shown left, TL1, a rigid and stable platform with fixed angle screen mount. Shown right, TL2, a trolley that can be powered up and down with a variable angled screen mount, manually operated through 90 degrees from horizontal to vertical. Full cable management is provided at the rear.

TABLEAU+

Operated by manual switch, screens can be commanded to rise or descend smoothly through 500mm, stopping safely when required. Screen angle can be manually moved through 90 degrees and locked at any point. Standard model TL2 comes with mount & full cable management.

Order Code	mm
TL2	for screens 46" - 70"

State screen make & model when ordering

Dedicated Screen Mounts



Approved mounts specifically designed for each make and model of screen listed

Xactmatch mounts take all the guesswork out of ordering and installing screen mounts whatever the make or model and whether stand, trolley, wall or ceiling fixed. Our range covers all popular makes of screens and are available in landscape or portrait versions.

- * Factory designed & tested for each screen model
- * Cable entry & cooling vent positions allowed for
- * Landscape and portrait versions for all models
- * Correct screen fixings included

Slimline Flat Mounts (Landscape)
 Order Code
PLX1 Screens up to 70" landscape - 80kg
PLX3 Screens 71" to 110" landscape - 150kg

Slimline Flat Mounts (Portrait)
 Order Code
PPX1 Screens up to 70" portrait - 80kg

State screen make & model when ordering

Tilting Mounts (Landscape)
 Order Code
PLW1 Screens up to 70" - 80kg
PLW3 Screens 71" to 110" - 150kg

Tilting Mounts (Portrait)
 Order Code
PPW1 Screens up to 70" - 80kg
PPW3 Screens 71" to 90" - 150kg

Xactmatch Rota Mounts

Smoothly rotate screens from landscape to portrait and anywhere in between.

Rota Mount RTM1 is designed to fit most Unicol stand & trolley models or floor to ceiling systems and can also be direct wall fixed if required. In-built safety stops allow precise indexing to both landscape and portrait positions.

Use Rota Mount in conjunction with our range of special Exactmatch slimline flat mounts, stating make & model of screen when ordering.

Order Code
RTM1 Screens up to 70" - Includes PLX mount

Higher capacity Rota Mounts for larger displays available - Call us for details.



Comes with screen mount
 Please state screen make & model
 Safety Note: Ensure safe cable management when using these units. Cables should be sheathed or otherwise protected and have sufficient freedom of movement.

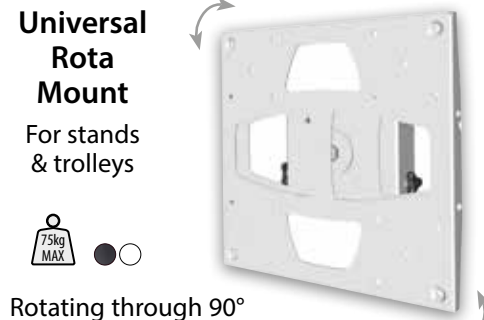

Universal Rota Mount
 For stands & trolleys
 Rotating through 90° this mount can also be adjusted from vertical to 5° tilt. Fits Avecta trolleys or stands.

Order Code
RTM10 Flat & 5° tilt - up to 70"
 Fits VESA sizes 200 x 200, 300 x 300 & 400 x 400

Sound Bar & Video Conference Sound Bar Mounts

Sound Bar Mounts

We design and manufacture sound bar mounts for many makes and models. These units allow sound bars to be fixed to our stands & trolley ranges and ceiling suspension systems by fixing to columns or universal mounts.

The SBM1 & SBM9 hook onto Universal Mounts. The SBT1 utilises the 150 x 150mm centres for twin screen central mounting.

Can be mounted above or below the screen.

Order Code
SBM1 Screens up to 70" - PZX/W 1&3, FCS1, ScreenRail & KP1&3
SBM9 Screens 71" to 110" - PZX9U, FCS4 & TCAVT
SBT1 Twin Screens up to 70"

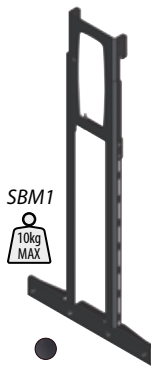

Video Conference Sound Bar Mounts

Sound bar mounts that include a camera mount for many makes and models are also available. Sound bars including cameras can be fixed to our stands & trolley ranges and ceiling suspension systems.

These are built for single or twin speakers and designed specifically for the make & model of speakers and camera.

Can be mounted above or below the screen.

Order Code
VCSS1 & VCSS9 Single Speaker + Camera Mount
VCTS1 & VCTS9 Twin Speaker + Camera Mount

Please state application, make & model of Sound Bar and Camera

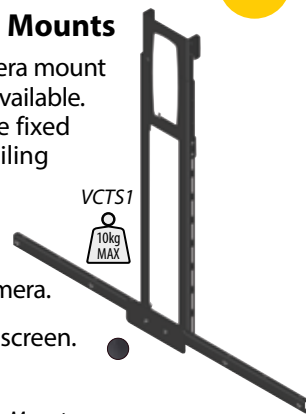

new

Universal Screen Mounts



Universal screen mount range

- * Double gang aperture and fixing slots
- * Flat & tilt versions, in landscape and portrait, all with screen levelling & optional security kits available
- * Fully adjustable - accommodates wide range of VESA screen options with fixing kit supplied covering M4, M5, M6 & M8
- * Use direct fixed to wall, also fits all stands, wall arms or ceiling mounts in our range

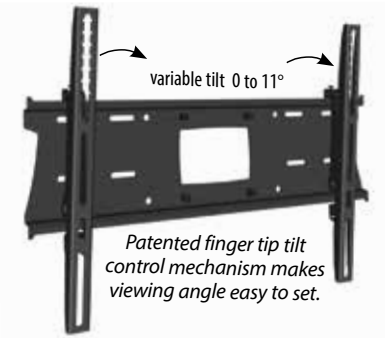

Flat to Wall Version - 30" to 40"
 Depth from wall 45mm

Order Code
PZX0 VESA 100 x 100 to 400 x 200
 Overall width / height of mount - 465mm x 332mm

Flat to Wall Version - 33" to 70"
 Depth from wall 45mm

Order Code
PZX3 VESA 200 x 200 to 400 x 400
 Overall width / height of mount - 540mm x 440mm

PZX1 VESA 200 x 200 to 600 x 400
 Overall width / height of mount - 765mm x 540mm

(For VESA 800 x 400 order **PZX5** - £98.40)
 (Overall width / height of mount - 870mm x 640mm)

Flat to Wall Version - 71" to 110"
 Depth from wall 50mm

Order Code
PZX9 VESA 1000 x 600
 Overall width / height of mount - 1070mm x 700mm
 (PPZX9 Portrait Version also available - same price)

Pozimount - Portrait

For screens - typically from 40" to 70" VESA 400 x 400 to 400 x 600

Flat to Wall Version

Order Code
PPZX2 depth from wall 45mm
 Overall width / height of mount - 465mm x 700mm

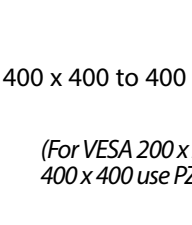
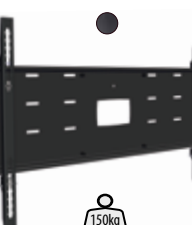
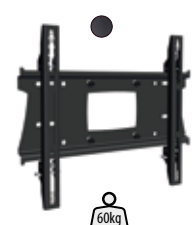

We offer stainless components to combat harsh environments when using waterproof / IP rated screens - Call us for details

Tilting Version - 30" to 40"
 Depth from wall 55mm

Order Code
PZW0 VESA 200 x 200 to 400 x 200
 Overall width / height of mount - 465mm x 332mm

Tilting Version - 33" to 57"
 Depth from wall 55mm

Order Code
PZW3 VESA 200 x 200 to 400 x 400
 Overall width / height of mount - 540mm x 440mm

PZW1 VESA 200 x 200 to 600 x 400
 Overall width / height of mount - 765mm x 540mm

Tilting Version - 58" to 70"
 Depth from wall 65mm

Order Code
PZW8 VESA 200 x 200 to 600 x 400
 Overall width / height of mount - 700mm x 536mm

Tilt Version (intended for column suspension mounting - add column adapter PS7, column & ceiling plate).

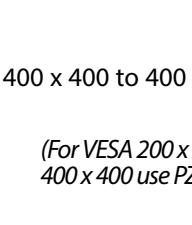

Video Conference Camera Mounts

Video Conference Camera Mounts

We have been designing and manufacturing video conference camera mounts for many makes and models for many years. These units allow video conference cameras or any small item to be fixed to our stands & trolley ranges and ceiling suspension systems where a screen is used.

There are a number of models that slot into our screen mount 150 x 150mm fixing arrangements. Other models hook onto the rails of our universal mount range providing options for all installations.

The models listed here have a 360(w) x 260(d)mm standard platform and we have a huge range of custom sizes specific to camera make & model.

Can be mounted above or below the screen.

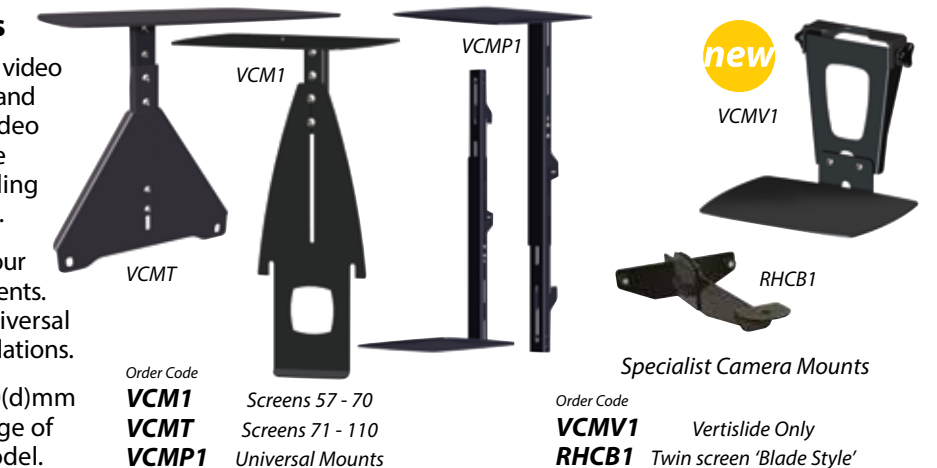

Order Code
VCM1 Screens 57 - 70
VCMT Screens 71 - 110
VCMP1 Universal Mounts

Order Code
VCMV1 Vertislide Only
RHC1 Twin screen 'Blade Style'

For custom camera platforms please provide make & model - Call us for details

Installation Components

Standard colour black – also available in white

Installation Components

Standard colour black – also available in white



Standard Ceiling Plate
Use with any column length for suspension of projectors & single screens up to 57".

Has cable entry

Order Code Plate holes mm
CP1 120 x 120

60kg MAX



Large Ceiling Plate
For long column or heavy installations typically up to 70" or twin 57" screens.

Has cable entry

Order Code Plate holes mm
CP2 240 x 240

120kg MAX



Stub Column Ceiling Plate
Useful in low headroom situations. Allows direct connection of Unicol PSU projector mounts etc.

Order Code Plate holes mm
CP3 120 x 120
CP4 240 x 240

60kg MAX
120kg MAX



Tilting Ceiling Plate
For sloping or 'out of level' installations. Projectors & single screens up to 57".

Has cable entry

Order Code Plate holes mm
CP6 120 x 120

60kg MAX



Gantry Ceiling Plate
Primarily for spider gantry units (See Page 35). Has internal safety mechanism that allows limited movement of suspension column to protect ceiling fixings.

Order Code Plate holes mm
CP5 300 x 300 & 500 x 500

270kg MAX



Anti-Vibration Ceiling Plate
Internal damping system provides floating action to reduce vibration from above.

Has cable entry

Order Code Plate holes mm
CPAV1 120 x 185

60kg MAX



Girder Clamps
For girders 75–250mm and 75–350mm wide. Adjust from level to extreme angles of tilt.

Has cable entry

Order Code Span mm
GC25 250
GC35 350

Wider span versions available.

120kg MAX



Twin Ceiling Plates
For suspension of screens over 50" & floor to ceiling column installations using floor plates FP8 (see below). CP9 360° swivel version also listed.

Has cable entry

Order Code Version Plate holes mm
CP8 Standard 220 x 180
Swivel 240 x 240

200kg MAX



Tube Clamp
For suspending screens from lighting gantries, show stands or other structures. Screens up to 57".

Has cable entry

Order Code
TM05 for 50mm tubes

45kg MAX



Truss Clamps
For suspending screens and projectors from standard truss. – fits truss 40 - 55mm dia

With safety hook

Order Code
CT1 up to 57" screens
CT2 with safety hook

Has cable entry

120kg MAX



Pipe Clamps
Available in a wide range of sizes. Please state pipe diameter when ordering.

Illustration shows 300mm version

Typical mount for 75 - 300mm pipe shown.

Has cable entry

Order Code
TM530

120kg MAX



Pillar Clamps
We manufacture these clamps in a wide range of sizes for circular pillars.

Order Code
VCC1 Single Arm
VCC2 Double Arm
(Triple-arm versions available - Call for details)

Typical unit shown for pillar diameter of 600 - 625mm

120kg MAX



Column Coupler
To enable columns with 'through bolt' holes to be joined together for vertical suspension. Coupler conceals neatly within column.

Order Code
CC

Note: For ceiling suspension use only

120kg MAX



Trim Disc Suspended ceiling finisher.
Order Code **TD1**

Retro Trim Disc Allows fitting after installation.
Order Code **TDRF**

Blanking Disc Blanks holes in ceiling tiles.
Order Code **TDB1**

new

120kg MAX



Safety Locking Ring
Necessary at the lower end of any ceiling suspension installation using column mounted components, where safety 'through bolts' are absent.

Order Code
LR

120kg MAX



Single Suspension Adapters
Single column mount adapter for Pozimount and Xactmatch mounts when used for ceiling suspension.

* 360° swivel

Order Code
PS1 Single column - up to 70"

Has cable entry

90kg MAX



Back-to-Back Single Suspension Adapter
Single column mount adapter for Pozimount and Xactmatch mounts when used for ceiling suspension.

360° swivel

Has cable entry

Order Code
PS5 up to 70"

90kg MAX



Column Tilting Adapters
Use with Pozimount and Xactmatch mounts when ceiling suspended.

* Variable tilt to 15°
* Back to Back version available

Order Code
PS7 Single Column
PS9 Twin Column

Has cable entry

new

60kg MAX



Twin Column Back-to-Back Suspension Adapter
We advise the use of Twin Column suspension for large / heavy back to back installations or screens which may be subject to stress or wind loads.

Order Code
PS4 Twin column - up to 70"
PS43030 Twin column - up to 110"

Has cable entry

120kg MAX



Twin Column Suspension Adapter
Twin column mount adapter for Pozimount and Xactmatch mounts when used for ceiling suspension.

Order Code
PS12 Twin column - up to 70"
PS123030 Twin column - up to 110"

Has cable entry

120kg MAX



Single Column Adapters
Use in conjunction with Pozimount and Xactmatch mounts to position screens vertically on columns. Can also be used for fixing single columns to walls.

Order Code
PS3U1 As illustrated, for screens 33"-70"
PS5T Back-to-Back version

90kg MAX



Floor to ceiling Column Coupler
For mounting screens on two part columns.

Order Code
PS6U1 for screens - 33" to 70"
PS6UT1 Back-to-Back version

Has cable entry

90kg MAX



Twin Column Adapters
Use in conjunction with Pozimount and Xactmatch mounts to position screens vertically on columns. Can also be used for fixing twin columns to walls.

Order Code
PS3V1 Twin column - 33" to 70"
PS8 Back-to-Back version

120kg MAX



Twin Column Floor to Ceiling Couplers
For mounting screens on two part columns.

Order Code
PS6V1 VS Range - 33" to 70"

Has cable entry

120kg MAX



Standard Column sizes

mm	Order Code	Chrome finish	Order Code	Stainless Steel	Order Code
500	500		500SS		500SS
1000	1000		1000SS		1000SS
1500	1500		1500SS		1500SS
2000	2000		2000SS		2000SS
2500	2500		2500SS		2500SS
3000	3000		3000SS		3000SS

We also offer non standard lengths per cm

Safety 'through bolt' holes must be used for suspension applications



Compact Bolt Down Bases
Offer minimal base footprint for fixed screen stands. M10 floor bolts (not supplied) fully recess into base. Trim caps complete the installation.

Order Code mm
ESF Single - 290w x 240d
VSF Twin - 400w x 300d
AVF Twin - 150mm centres

120kg MAX

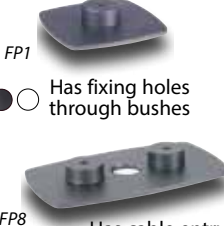

Floor to Ceiling Base Plates
In single or twin column versions. Columns locate securely over bushes to give neat appearance.

Order Code
FP1 Use with CP1 (see page 22)
FP8 Use with CP8 (see above)

Has fixing holes through bushes

Has cable entry

Custom Made Accessories
We offer a service in making all kinds of special or non-standard accessories – Call us when planning your next installation.



Example RSJ Clamp, Example Extended Socket, Example Purlin Clamp

Universal Screen Mount – Trade Packs

Trade Packs for screen suspension

These 'package priced' kits offer ease and convenience for specifiers and installers, combining the necessary ceiling plate, column & universal tilting mount for a typical installation.

Three column lengths are listed to suit different ceiling heights. Trade Packs consist of ceiling plate, column & mount(s).

Note: All white versions are now available, including columns – Please call for details. new

Single Screen Trade Packs for VESA 300 x 300 to 600 x 400

Order Code
KP110CB with 1m suspension column

KP120CB with 2m suspension column

KP130CB with 3m suspension column

* (please see note below – smaller size mount options)



60kg MAX

Typically 40-70" screens

45kg MAX per screen



Back to Back Twin Screen Trade Packs for VESA 300 x 300 to 600 x 400

Order Code
KP110DB with 1m suspension column

KP120DB with 2m suspension column

KP130DB with 3m suspension column

* (please see note below – smaller size mount options)

For 32" Back-to-Back screens with VESA 200 x 200 fixings use CP1, Column length & DCV1

Wall Arm Trade Packs for VESA 200 x 200 to 600 x 400

Order Code
KPWB Direct coupled

KP105WB with 50cm suspension column

KP110WB with 1m suspension column

* (please see note below – smaller size mount options)

60kg MAX

KPWB

* **Note:** The above Trade Packs use PZW1 style mounts. Smaller PZW3 style mounts (P21) for VESA 200 x 200 to 400 x 400 are also available at same price – Call for details.



KP110CB



KP110DB



Slim Profile & Other Mounts

eXcalibur™ Ultra Slim Universal Wall Mounts

- * Only 7.5 millimetres thin!
- * For screens up to 57" (max 35Kg)
- * Fits all of the following VESA sizes: 200x200 / 300x300 / 400x400 / 600x400

Order Code
UTM with 680mm wall plate
with 500mm wall plate

(Caution: Please check that your screen has cabling connections which allow the use of a slim style wall mount and do not protrude excessively from the rear).

Versus Mount Range

As screens become lighter it is only natural to have a mounting system that shows off the virtues of Direct and Edge Lit LED technology.

This range of screen mounts is available in wall, stand or ceiling versions, tilting & non-tilting. The ceiling version is supplied with an adapter to fit a standard column. The trolley version fits directly to a standard PS2 twin column adapter.

The wall version has ample room for services and folds down into a small package for easy stocking. All versions fit the most popular VESA fixing centres.

Tablet Mounts



Ideal for point of sale, these mounts are suitable for most sizes of tablet.

Can be fitted to a wall or single column stand and encases your tablet in a steel shell offering anti-tamper protection.

Order Code
TBM1 7" to 11" screens, 100 x 100 VESA
TBM2 11" to 15" screens, 100 x 100 VESA

Please provide make & model of Tablet when ordering. POE adapters can also be accommodated.

10kg MAX

Typically 7-15" screens

Ceiling Mount Version

Order Code
VZWC1 0 to 10 degrees tilt
200 x 200, 300 x 300, 400 x 400, 600 x 400
Add ceiling plate, column & PS2 as required

Wall Mount Version Only

Order Code
VZWW1 flat to wall
VZWW2 0 to 11 degrees tilt
200 x 200, 300 x 300, 400 x 400

VS1000 Trolley Version

Order Code
VZVW1 0 to 10 degrees tilt
200 x 200, 300 x 300, 400 x 400, 600 x 400



Ceiling



Wall



Trolley

40kg MAX

Typically 40-57" screens

Small Screen Mount Range



20kg MAX

Slim-Line Wall Mount

- * For displays up to 21"

Order Code
LVC VESA up to 100 x 100



35kg MAX

Clip-On Slim-Line Wall Mount

Easy to use, fits most screens and has concealed security screw.

- * For displays up to 32"
- * VESA 75 x 75, 100 x 100, 200 x 100

Order Code
SVC1 VESA up to 200 x 100
SVC2 VESA only 200 x 200



8kg MAX

Swivel & Tilt Mount

- * For displays up to 21"
- * VESA 75 x 75 and 100 x 100

Order Code
LVA Tilt Only
LVB Swivel & Tilt



15kg MAX

Lectern style screen mount

For use with touch screens or in show room displays. Tilt angle fully adjustable.

- * For displays up to 32"
- * VESA 75 x 75, 100 x 100, 200 x 200

Order Code
SEV1 VESA up to 200 x 200



15kg MAX

Tilting Wall Mount

- * For displays up to 32"

Order Code
STV1 VESA up to 200 x 200
SMV1V with Swivel & Tilt

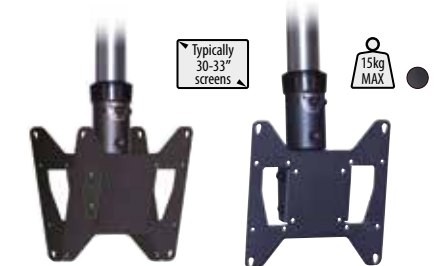

Typically 30-33" screens

15kg MAX

Suspension units with swivel & tilt

Use with any Unicol ceiling or wall suspension equipment.

Order Code
SCV1 VESA up to 200 x 200
DCV1 Back to Back version

UNICOL PANARM™

Range of Swivel Arms

All steel, lasting quality, user adjustable joint tensioning, full swivel & tilt plus screen levelling

SSV Dual Arm Shown



EU Registered Design

Compact Single & Dual arms for screens up to 32 inch

The extra versatility of our dual arm units provide increased viewing flexibility – good also in alcoves or corner situations. Unit folds 77mm to wall and reaches 460mm fully extended. Mount plate fits all small screen VESA sizes, has tilt to 10 degrees plus screen levelling fine adjustment.

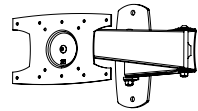
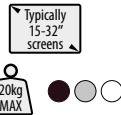

Order Code

- SRV** Single Arm – Fits VESA 75 x 75, 100 x 100, 200 x 100
- SSV** Dual Arm – Fits VESA 75 x 75, 100 x 100, 200 x 100

These heavy duty (35Kg rated) swivel arms are fitted with our Pozimount universal screen mounts. Each arm version (single or dual) is listed with mounts suitable for either standard or small screen / portrait use.

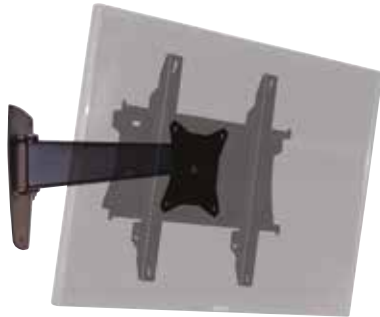

EU Registered Design

HD Single arm for screens up to 57 inch

Arm fully extends to 430mm (115mm when folded flat) has full swivel & tilt plus screen levelling feature.

Order Code

- PLS1X1** Fits VESA 200 x 200 to 600 x 400 (With Pozimount PZX1 for most standard applications)

- PLS1X3** Fits VESA 200 x 200 to 400 x 400 (With Pozimount PZX3 for small (32") screens or portrait mounting)

(For full Pozimount details see page 21)

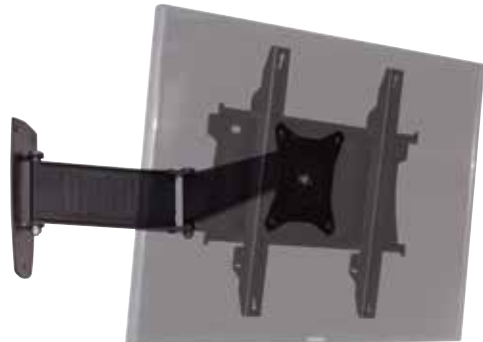
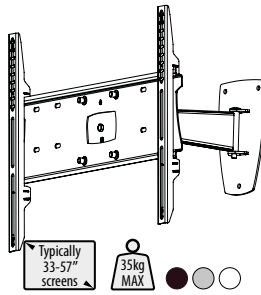

EU Registered Design

HD Dual arm for screens up to 57 inch

Offers enhanced degree of adjustment for more extreme viewing angles – arm fully extends to 730mm (155mm when folded flat) has full swivel & tilt plus screen levelling feature.

Order Code

- PLA1X1** Fits VESA 200 x 200 to 600 x 400 (With Pozimount PZX1 for most standard applications)

- PLA1X3** Fits VESA 200 x 200 to 400 x 400 (With Pozimount PZX3 for small (32") screens or portrait mounting)

(For full Pozimount details see page 21)

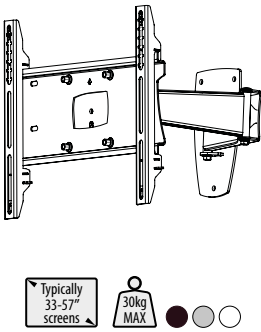

HD "Parallel Action" Dual arm for screens up to 110 inch

Robust construction for screens up to 130kg. Able to swivel left or right as well as track in and out in a parallel manner where its use in alcoves (but not exclusively) works particularly well.

Unit fully extends to 535mm. 126mm when closed. Comes complete with fine adjustment features for accurate screen positioning and has a cord release latch for locking when closed. Adjustable stops are included on the screen arms to prevent screens being pushed in at the sides – particularly useful when using touch screens.

Order Code

- PLA4** Fits VESA 400 x 400 - 900 x 600 (Comes with fully adjustable arms)

Please provide us with the make and model of your screen.

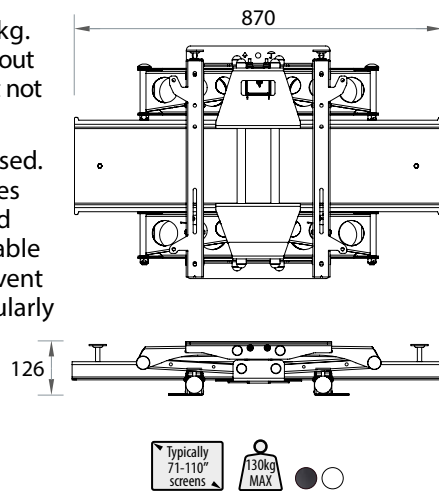

UNICOL Wall Arm System

Wall suspension for screens, projectors, Guardboxes etc.

These standard wall arm units are designed for use with any of our screen or projector mounts, Guardboxes etc.

We manufacture two versions; WB1 allows direct connection of mount (using PS1 suspension adapter) and WB2 as a suspension column version. Wall arms can be fitted with any Unicol screen or projector mount listed in this catalogue.

See pages 20 & 21 for screen mounts and page 23 for PS1 adapter.



Order Code
WB0 Peg
WB02 Socket

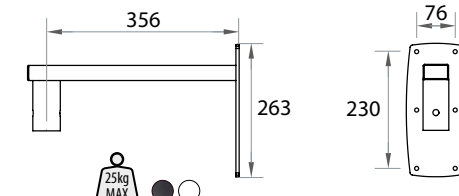

Order Code
WB1 Peg

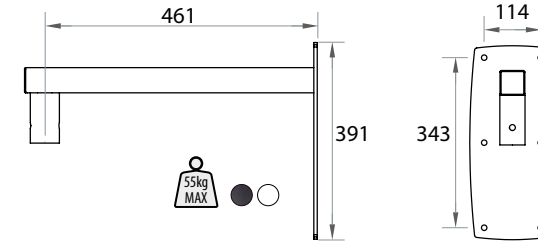

Order Code
WB2 Socket

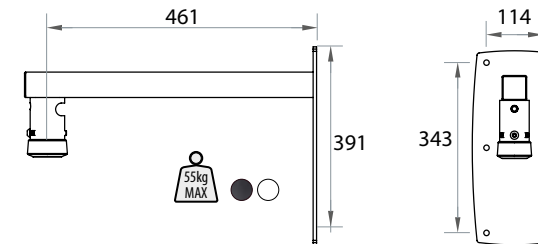

Other arm lengths (mm) are available – Call us for details.



HD "Parallel Action" Dual arm for screens up to 70 inch

Robust construction for screens up to 60kg. Able to swivel left or right as well as track in and out in a parallel manner where its use in alcoves (but not exclusively) works particularly well.

Unit fully extends to 520mm. 150mm when closed. Adjustable tilt built in.

Order Code

- PLA2X1** Fits VESA 300 x 300 to 600 x 400 (Comes with Pozimount PZX1)

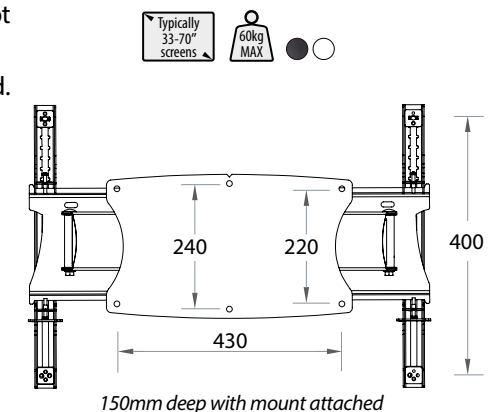
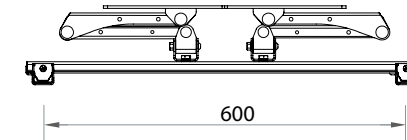

Outdoor Housings in Landscape or Portrait

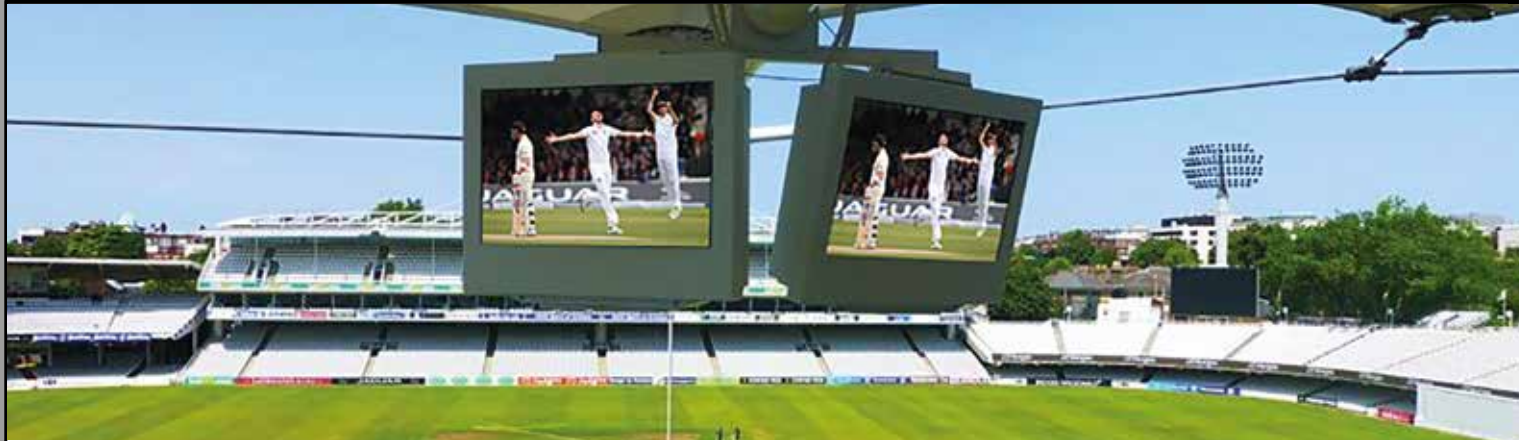

Outdoor Housings for up to 86" screens

UNICOL pioneered the development of outdoor housings and has unrivalled experience in this specialised field. Our well proven range of housings go from small screen monitors used in harsh environments right up to the latest 80inch large format screens.

All are constructed in 1050 grade aluminium and utilise high quality temperature control components within. Screen viewing panels in impact resistant polycarbonate are incorporated as standard. Toughened or laminated glass is also available as an option.

For the Technical – housings all feature the following:

– In Landscape or Portrait –

- * Tailor made for perfect screen fit every time
- * Wide range available – 32" to 86" screens
- * IP53 rated with vandal resistant screen
- * Corrosion free for long life in all weathers
- * Light weight aluminium construction
- * Wall, ceiling or back-to-back mountable
- * Thermostatic internal heating & cooling
- * User replaceable cartridge air filtration

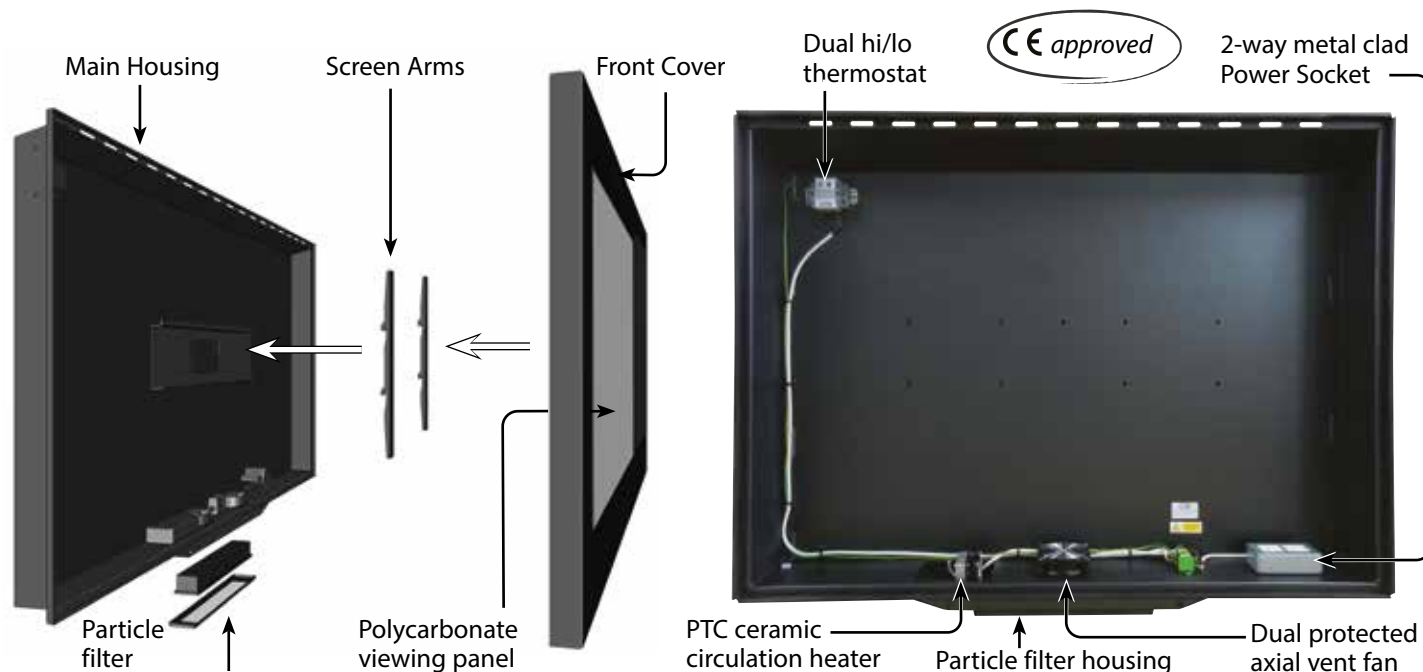

Typically 30-80" screens

Order Code
ODH0 Square Corners – 30" to 32"
ODH1 Square Corners – 33" to 57"
ODH2 Square Corners – 58" to 70"

Order Code
ODH3 Square Corners – 80"
ODH4 Square Corners – 86" Stretched
 Anti-reflective screen – additional price

* Slimline screens have enabled us to manufacture these housings in our new slimline style. These will always be supplied where the screen depth allows. – Please call us for confirmation if needed.

Protective Covers



Protective Covers for up to 70" screens

Screen Protective Covers

5mm thick, clear, anti-shatter screen with a metal bezel provides a durable front cover for screens.

Two landscape versions are available, one that clips to the screen (square corners only), the other attaches to the wall (square & rounded corners available). For portrait versions use order code PCP instead of PCL below. Anti-reflective screens also available.

We can supply bespoke versions in branded colours including logos. – Call for details.

Landscape clip-on (square corners)

(Screen mount required with these units)

Order Code Minimum 5mm screen bezel
PCL0 Clip-on - 15" to 32"
PCL1 Clip-on - 33" to 57"
PCL2 Clip-on - 58" to 70"

Landscape wall mounted (square or rounded corners)

(Screen mount included with these units)

Order Code Square corners
PCL5 Wall mounted - 15" to 32"
PCL7 Wall mounted - 33" to 57"
PCL8 Wall mounted - 58" to 70"

Order Code Rounded corners
PCL10 Wall mounted - 15" to 32"
PCL11 Wall mounted - 33" to 57"
PCL12 Wall mounted - 58" to 70"

Anti-reflective screen – additional price

Typically 15-70" screens

Typical landscape clip-on version with square corners



Portrait wall mounted Cover PCP7 with standard square corners. (bespoke screen branding retained) – Heathrow Airport T5



Portrait wall mounted Cover PCP11 with rounded corners London City Airport



Rear Covers

We design and manufacture custom made rear covers for a wide range of screen sizes. These enhance any installation and provide a neat appearance enabling cables & connections to be hidden when screens are installed in open areas.

Full screen versions or partial covers to enclose only the cables & connections are available.

Order Code
BCW1 Full covers - screens 33" to 57"
BCW2 Full covers - screens 58" to 70"

Typically 33-70" screens

Call us for details quoting make & model of screens being installed



The UNICOL Difference

Why our outdoor housings and covers look so good and work so well is because each one is tailor made to perfectly fit the screen of your choice. Our dedicated Oxford manufacturing facility enables us to do this, with all Outdoor Housings made in durable corrosion proofed aluminium for long term good looks.

All offered with a reliable & prompt delivery service, usually within 5 to 7 days – **a perfect result in rapid time!**



Obelisk Digital Signage System

Column style enclosures for large format screens in free standing, floor-fixed and floor to ceiling versions. Custom options available including transparent screens with display cabinet and multi-screens. Custom colours and branded versions also available.

Our Special Projects Design department has been engaged in the ongoing development of these units and can produce conceptual and production versions for many varied applications. Standard portrait versions shown below and listed on opposite page (Landscape versions also available). For custom projects please contact us to discuss specification and options.

STANDARD Column Style

Free-standing & Bolt Down



46" - 75" Screens
2m high

Floor to Ceiling



Single or Double Sided

CUSTOM Column Style



new 4 sided Quad Totem for LG 86" stretch

Colour & Branding Options

- * Single or back-to-back displays
- * Easy to assemble and install
- * Wide choice of screen options
- * Landscape versions available
- * Laminated glass option
- * Polycarbonate screen cover option
- * Analytic Camera mount option
- * POS Shelf options available
- * Space for players and PCs
- * Branding options available
- * Colours in Sinterflex Black or White
- * Other colour finishes available
- * Rapid turnaround on orders

60kg MAX Typically 40-75" screens - Call us for details

new

Obelisk Edge-Line Enclosure

Designed for double-sided screens such as the Samsung OMN-D 46" & 55" displays, this clean faced design enhances contemporary interiors. Available in freestanding or bolt down versions.

Screen Size / Type	Installation	Order Code
46 / Double	Freestanding	ODS46FS
46 / Double	Bolt Down	ODS46BD
55 / Double	Freestanding	ODS55FS
55 / Double	Bolt Down	ODS55BD

Please specify screen make and model when ordering. Other screen sizes available upon request.



Freestanding Kiosk	Screen Size	Order Code	Single Sided	Order Code	Back to Back
	30 - 39	KTC3FS		KTC3FSB	
	40 - 49	KTC4FS		KTC4FSB	
	50 - 59	KTC5FS		KTC5FSB	
	60 - 69	KTC6FS		KTC6FSB	
	70 - 79	KTC7FS		KTC7FSB	

Bolt Down Kiosk	Screen Size	Order Code	Single Sided	Order Code	Back to Back
	30 - 39	KTC3BD		KTC3BDB	
	40 - 49	KTC4BD		KTC4BDB	
	50 - 59	KTC5BD		KTC5BDB	
	60 - 69	KTC6BD		KTC6BDB	
	70 - 79	KTC7BD		KTC7BDB	

Floor to Ceiling	Screen Size	Order Code	Single Sided	Order Code	Back to Back
	30 - 39	KTC3FC		KTC3FCB	
	40 - 49	KTC4FC		KTC4FCB	
	50 - 59	KTC5FC		KTC5FCB	
	60 - 69	KTC6FC		KTC6FCB	
	70 - 79	KTC7FC		KTC7FCB	

Freestanding Totem	Screen Size	Order Code	Single Sided	Order Code	Back to Back
	30 - 39	KTC3FST		KTC3FSTB	
	40 - 49	KTC4FST		KTC4FSTB	
	50 - 59	KTC5FST		KTC5FSTB	
	60 - 69	KTC6FST		KTC6FSTB	
	70 - 79	KTC7FST		KTC7FSTB	

Bolt Down Totem	Screen Size	Order Code	Single Sided	Order Code	Back to Back
	30 - 39	KTC3BDT		KTC3BDTB	
	40 - 49	KTC4BDT		KTC4BDTB	
	50 - 59	KTC5BDT		KTC5BDTB	
	60 - 69	KTC6BDT		KTC6BDTB	
	70 - 79	KTC7BDT		KTC7BDTB	

* For custom versions please call for details. (Larger screen versions are possible).

Pop Out Video Wall Mounts

ADAPTA-WALL®

Patent Pending Registered Design

The installer friendly Pop Out mount loaded with innovative features.

- * With standard 'Push to close - Push to open' action. Also available with remote latching system where closure with no screen contact in the case of ultra thin displays is required.
- * For screens up to 45Kg with fixings; VESA 200 x 200 to 800 x 400mm.
- * Full screen adjustment in all planes.

- * Accurate horizontal / vertical centre line marks on all back plates for easy set up.
- * For direct wall fixing or use with our video wall structure components for ceiling, floor to ceiling or floor to wall applications.
- * Optional 'pull cord' security feature prevents unauthorised 'Pop out' operation in public areas or any situation required.



95mm - 350mm -

Compact Version

Order Code
VWPO

new

The compact size of this version is for screens up to 40" and covers VESA sizes 100 to 300mm Comes complete with fine adjustment features for accurate screen positioning.

Wall Plate dims: 410w x 500h
Fits VESA: 100 x 100mm 200 x 200mm 300 x 200mm

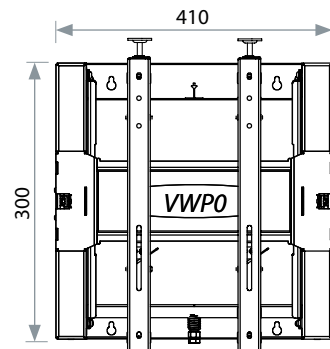

95mm - 350mm -

Standard Version

Order Code
VWP1

All Adapta-Wall mounts come with a wide range of VESA fixing sizes, complete with fine adjustment features for accurate screen positioning.

Wall Plate dims: 800w x 500h
Fits VESA: 300 x 300mm 400 x 400mm 600 x 400mm

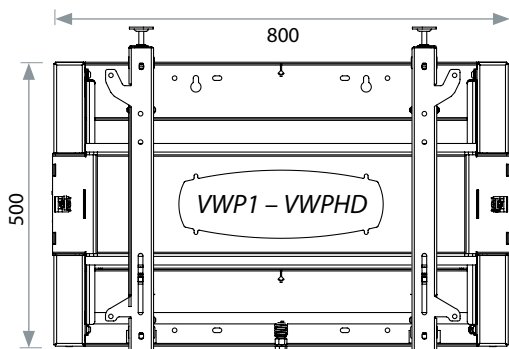

For screens with VESA 800 x 400mm fixing points a stretched version, VWP3 is available.



95mm - 350mm -

Heavy Duty Version

Order Code
VWPHD

new

This version is ideal for single screens mounted in recesses. It has all the characteristics of the standard version but carries heavier screens up to 80kg.

Wall Plate dims: 800w x 500h
Fits VESA: 300 x 300mm 400 x 400mm 600 x 400mm

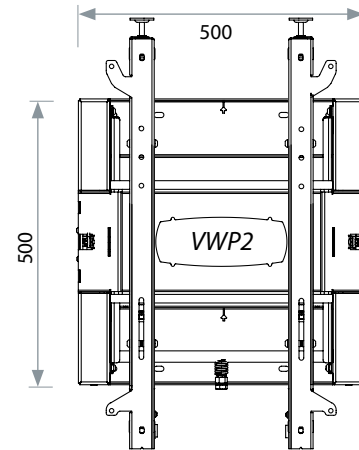

95mm - 350mm -

Portrait Version

Order Code
VWP2 VESA 400 x 600
VWP4 VESA 400 x 400

The compact (500mm) width of this version allows use of screens in portrait mode. The two models listed have the same back plate but come with two different sets of arms to cover a wider range of VESA fixings.

Wall plate 500w x 500h
VWP2 - Fits VESA 400 x 600mm VWP4 - Fits VESA 400 x 400mm

All versions can be wall fixed or used with our Adapta-Wall structure system fittings below. For ceiling suspension use (Quad) 4 column parts, (locking rings must be used - P23). For floor to ceiling / wall, use (Twin) 2 column parts.

Ceiling, Wall & Floor Plates

Order Code
VWPA10 Quad Ceiling Plate
VWPA11 Quad Floor Plate

Order Code
VWPA2 Twin Ceiling Plate
VWPA4 Twin Floor Plate
VWPA9 Wall Plate

Mount U-Clamps (set of 4)

Order Code
VWPA5 Fits mounts to columns

Quad Tie Brace Units (pair)

Connects vertical & horizontal columns.
Order Code
VWPA1 Tie brace units (pair)

Free Standing Video Walls & Roller Trak



Free-standing video wall system

Ideal for situations when quick, easy and accurate assembly is required such as hire and retail, where regular change is inevitable.

This robust modular structure is made of individual mast units that are joined with cross members enabling a 4-high display unit to have infinite width (3-high display units are also available). Cable management runs are catered for and there is adequate space for players or PCs.

Each display fixes to the VWP1 standard 'Push to close - Push to open' video wall mount capable of VESA 200 x 200 to 800 x 400, for displays up to 45kg, (see Page 32). The mount allows for tool-less adjustment in all planes by means of knurled wheels for in-out and up-down movement. Lateral action is achieved by sliding the display smoothly on wheels located in the mount arms.

- * Robust modular construction
- * Easy to assemble and install
- * Wide choice of screen options
- * Space for players and PCs
- * Discreet cable management
- * 'Push to open' - 'Push to close' mounts
- * Tool-less screen adjustment

- Call us for details

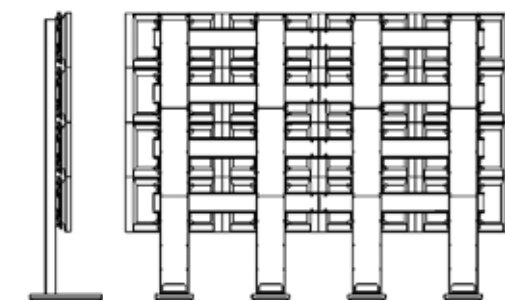
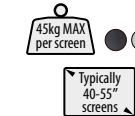

Image shows 3 x 3 wall with 55inch displays.

Illustration shows 4 x 4 wall with 46inch displays.



Shop Window Solutions

Ideal for retail and other applications to enable screens to be tracked in / out & from side to side, thus opening exciting possibilities for window displays, dynamic presentations, servicing needs or just access for screen / store front cleaning.

AV Roller Trak system consists of track lengths of standardised design which carry smooth running ball bearing trolley units. Standard Unicol column lengths & screen mounts complete the installation.

AV Roller Trak™



Typical roller track in window display use

- * Smooth, easy glide operation
- * Single or multiple screens
- * Wide choice of track lengths
- * Swivel or Rotamount options

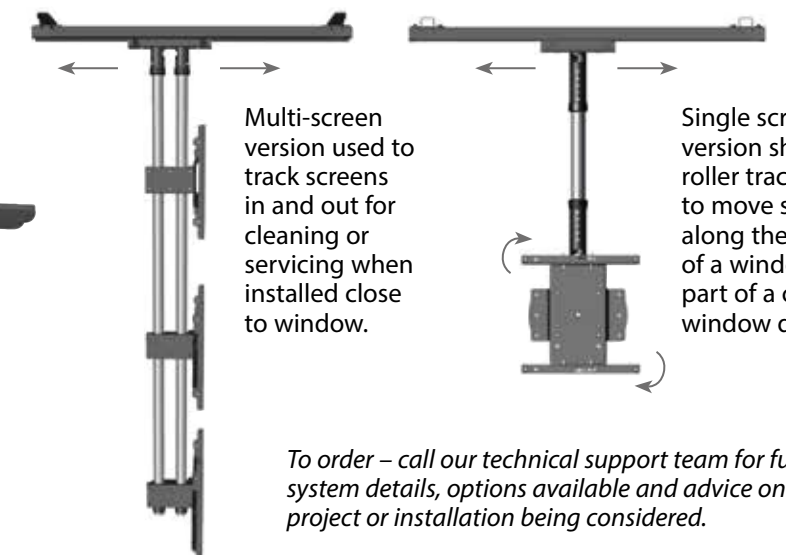

Multi-screen version used to track screens in and out for cleaning or servicing when installed close to window.

Single screen showing roller track used to move screens along the length of a window as part of a changing window display.

To order - call our technical support team for full system details, options available and advice on any project or installation being considered.

ScreenRail Universal Multi-Display System

ScreenRail™

- * Ceiling Suspended
- * Wall mounted

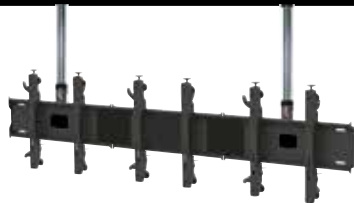

ScreenRail Multi-Display System

A highly adaptable rail system for mounting screens in-line, in any number. Ideal for Digital Menus, Videowalls & Telepresence, etc. Can be wall mounted and ceiling suspended. ScreenRail system comprises a choice of standard rail modules and a range of screen arms to cover all applications. Back to Back versions also available.

When selecting parts consideration has to be given to screen width & VESA fixing size. The examples of menu boards and videowalls below use **VWA** adjustable arms. We have given these specific codes for ease of ordering but we urge you to check before ordering by providing us with the make & model of your screen. Ceiling suspension examples use 1.5m columns.

Menu Boards

Wall mounted & ceiling suspended.

These kits consist of all parts necessary for fixing screens in line on a wall or ceiling suspending on 1.5 columns.



1 x 3 (wall mounted)

Order Code	Screen
MBW346	46"
MBW350	50"
MBW355	55"

1 x 4 (wall mounted)

Order Code	Screen
MBW446	46"
MBW450	50"
MBW455	55"

1 x 3 (ceiling suspended)

Order Code	Screen
MBC346	46"
MBC350	50"
MBC355	55"

1 x 4 (ceiling suspended)

Order Code	Screen
MBC446	46"
MBC450	50"
MBC455	55"

Video Wall – Wall mounted

By fixing appropriate rail lengths on a wall a video wall can be assembled. Here are examples of 2x2, 3x3 and 4x4 video walls for leading brand 46", 50" and 55" displays. You should check before ordering by providing us with the make & model of your screen.

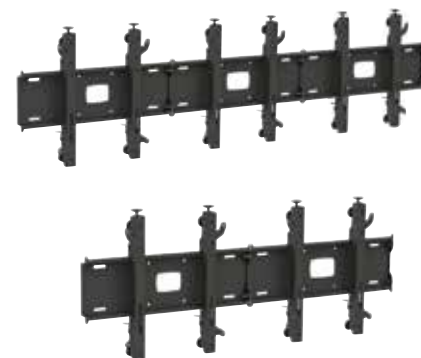

2 x 2 Video Wall

Order Code	Screen
MV246	46"
MV250	50"
MV255	55"

3 x 3 Video Wall

Order Code	Screen
MV346	46"
MV350	50"
MV355	55"

4 x 4 Video Wall

Order Code	Screen
MV446	46"
MV450	50"
MV455	55"

Standard Universal Arms

Pozimount universal mount arms. Supplied with M4, M5, M6 & M8 fixing screws. Arms incorporate 5mm screen levelling feature and are 45mm deep.

Order Code	length	VESA
PZF0	330mm	200
PZF3	440mm	400
PZF5	640mm	600
PPZF5	840mm	800

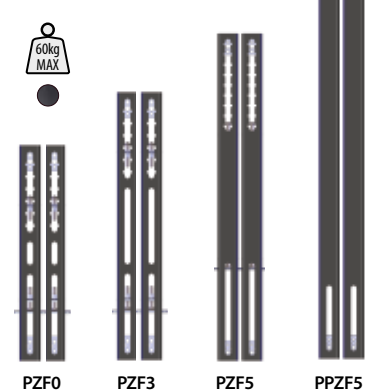

Tool-less Fully Adjustable Arms

Feature 15mm in-out adjustment and 15mm of levelling fine adjustment. Side to side adjustment included.

Order Code	VESA
VWA1 Landscape	400
VWA2 Portrait	600

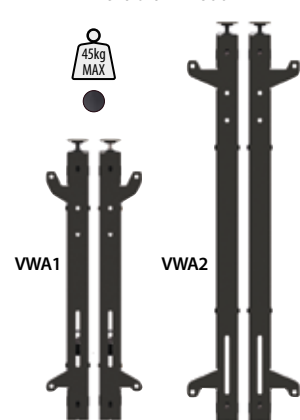

Rail Modules

In 3 standard lengths, all with full interchangeability. Provision for bolting together as required. May be ceiling suspended or direct wall fixed, with or without tilt extension brackets (SR10 / SR20).

Order Code	mm (w - h - d)
MD2U35	350 x 235 x 33
MD2U70	700 x 235 x 33
MD2U140	1400 x 235 x 33

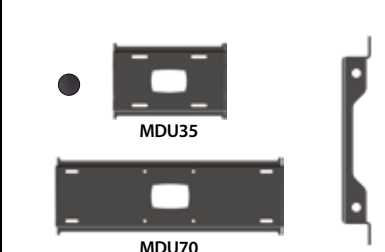

Other lengths of rail are available to order: 450(w), 800(w), 1000(w), 1200(w), 1700(w), 1800(w), 2100(w) – Call for details

Fixed Tilt Stand-off Brackets

Use these optional brackets to provide tilted display whenever required. 10 or 20 degree tilt versions listed.

Order Code	Tilt
SR10	10° tilt (pair)
SR20	20° tilt (pair)



Multi-Screen Gantry Systems

Spider Gantries

These ceiling mounted units are available for a wide range of screen sizes incorporating our Pozimount universal tilting screen mounts. The spider style and single column gantry versions have swivel capability and all have cable entry ports for neat installation.

By their very nature all spider style and in-line gantries incorporate parts which are factory made to suit specific requirements but all versions are available on a short turn round basis.

Call our technical support team for advice on any project or installation being considered.



Spider – triple screen unit



* We also manufacture gantries for projectors – Call us for details

Spider – five screen 'pentagon' unit



CP5 Ceiling Mount

In-line Gantries



Single sided In-line gantry



Back-to-back In-line gantry



Spider five screen gantry - illustration shows typical gantry main frame. Add heavy duty column / CP5 ceiling mount (special to these gantries) & screen mounts (pages 20/21).

Order Code	Description
SG3	3 screen spider gantry - max weight per screen 50Kg
SG4	4 screen spider gantry - max weight per screen 50Kg
SG5	5 screen spider gantry - max weight per screen 40Kg
CP5	Large gantry ceiling mount for use with above (Page 22)

Order Code	Bar Length (mm)
DIG1050	100-500
DIG50100	500-1000
DIG100150	1000-1500
DIG150120	1500-2000

Order Code	Description
MSS1	Bolt on socket
MSP1	Bolt on peg

In-line gantries require MSS1 sockets and MSP1 pegs (above), Single sided require PS1s, Back-to-Back PS5s (Page 22). All require Screen Mounts (Pages 20/21).

Product codes & prices listed are intended as a guide as most gantry installations are 'project driven' with the make/model & number of screens as well as the location already chosen. Call our technical team who have wide experience in advising the necessary mount component 'package' to best meet the needs of your installation.



Floor to Ceiling and Floor to Wall Systems

- * Single sided and back to back screen versions
- * Cable management within column uprights
- * Floor to ceiling and floor to wall options

Below are three standard methods of floor to ceiling / wall installation. Select any of the trade kits listed (for nominal ceiling heights of 4m).

If the kits do not meet your needs order in component form as required. To enable adjusting heights of screens at installation, long column lengths can be ordered separately with standard adapters. If services are from the floor use ESF or AVF floor plates (Page 22) for cable management.

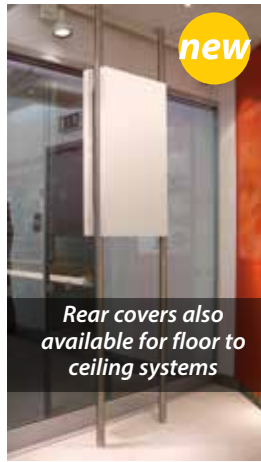

Single column

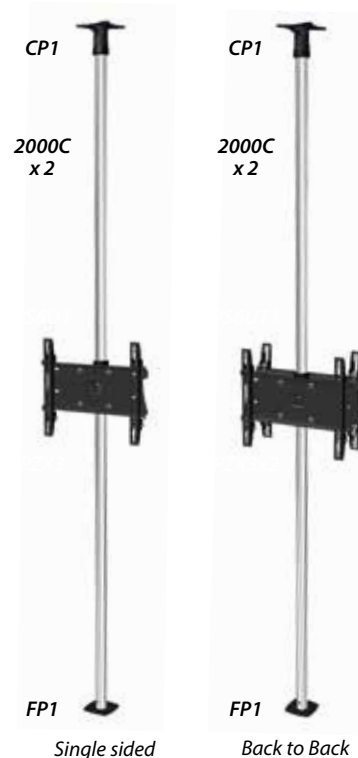

Twin column

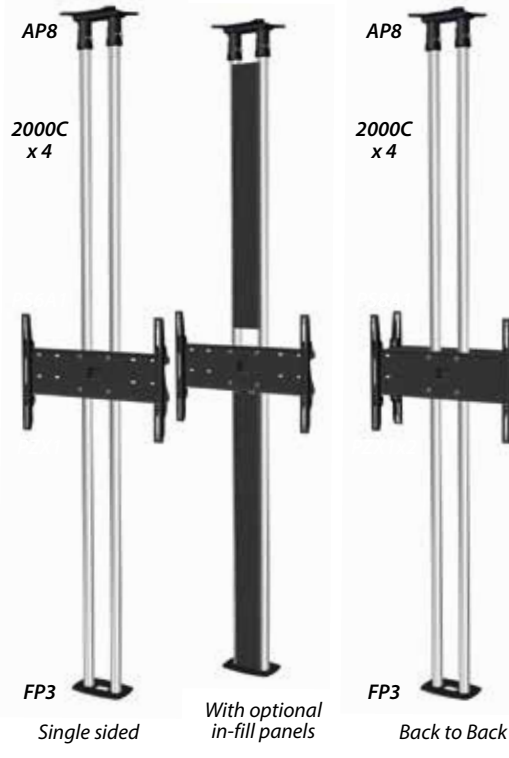

Goal post style for large screens



Floor to ceiling single column kits:

- Order Code
- FCUS3** up to 57" - single screen
 - FCUD3** up to 57" - back to back

Floor to wall single 2m column kit:

- FWUS3** up to 57" - single screen

Floor to ceiling twin column kits:

- Order Code
- FCAS1** up to 70" - single screen
 - FCAD1** up to 70" - back to back
 - FCAVM** optional set of In-fill panels

Floor to wall twin 2m column kit:

- FWAS1** up to 70" - single screen
- FWAVM** optional set of In-fill panels

Floor to ceiling 'goal post' style kits:

- Order Code
- FCGS1** up to 70" - single screen
 - FCGD1** up to 70" - back to back
 - FCGSH** up to 110" - single screen
 - FCGDH** up to 110" - back to back

Floor to wall 'goal post' style kits:

- FWGS1** up to 70" - single screen
- FWGSH** up to 110" - single screen

Floor to Ceiling Adapters

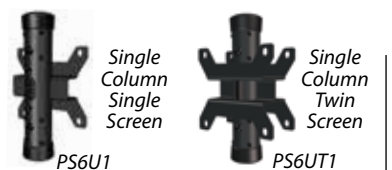

Screen mount adapters with integral cable management.

- Order Code
- PS6U1** Single Screen
 - PS6UT1** Twin Screen

Floor to Wall Adapters & Fixing Brackets



Twin column version with integral cable management.

- Order Code
- PS6A1** Single Screen
 - PS8A1** Twin Screen



Screen mount adapters for single & twin column use.

- Order Code
- PS3U1** Single Column
 - AV2** Twin Column



Wall fixing brackets for single & twin column use.

- Order Code
- CTS** Single Column
 - CTT150** Twin Column

Universal Sliding Serviceable Cassette Mounts



The Sliding Serviceable Cassette Mount range consists of wall fixed or under desk mounts with vertical, horizontal or folding slotted cassettes that can be populated with AV peripherals.

The VertiSlide Serviceable Cassette Mount range consists of wall fixed screen mounts with vertical or horizontal sliding & detachable slotted racks for mounting AV equipment. There are three models for different screen sizes. The equipment is hidden behind the screen. Depending on the model, in the event of a swap out the rack can be unlocked, slid down or across and detached if necessary. VertiSlide is a universal unit designed for most screens with the rack positioned towards the bottom of the screen.

An under desk version is also available and incorporates a hinged slotted removeable rack for mounting AV equipment such as players etc. When installed the equipment is hidden under the desk but in the event of a swap out the rack can be unlocked, hinged down and detached if necessary to carry out the maintenance. Has easy close counterbalance mechanism.



Horizontal Serviceable Cassette Mount

- Order Code
- HTS1** Screens - 71" to 110" max 110kg
VESA - 200 x 200 to 1000 x 600
 - HTS2** Screens - 46" to 70" max 60kg
VESA - 200 x 200 to 600 x 400

Vertical Serviceable Cassette Mount

- Order Code
- VTS1** Screens - 71" to 110" max 110kg
VESA - 200 x 200 to 1000 x 600
 - VTS2** Screens - 46" to 70" max 60kg
VESA - 200 x 200 to 600 x 400

Under-Desk Serviceable Cassette Mount

- Order Code
- UDM1**

Custom sizes available. State screen make & model and AV equipment being fitted when ordering.

Video conference camera mount VCMV1 also available See Page 21

PC / Player Housings & Racks



Housing inner dimensions 320(w) x 100(d) x 330(h) mm

Screen Mount / PC housing combinations

We manufacture screen mounts incorporating housings for small form factor PCs. These units greatly reduce installation time. Units are listed below incorporating our Pozimount universal mounts in tilting & non-tilting versions.

Custom made, security locking versions & power socket options also available.

- Order Code
- PCZW** Universal PC Housing Tilting
 - PCZX** Universal PC Housing non-Tilting



State make & model of screen & PC to be housed

Typical custom made units shown.

Projector Suspension Units

Standard colour Sinterflex black – also available in white



Copyright: Hilary Lloyd, Photo courtesy of Sadie Coles HQ, London

Our PSU (Projector Suspension Unit) range covers all makes of projectors. Each mount is specifically designed for the individual projector models listed, supporting the projector either inverted or in a cradle according to manufacturer's recommendations.

Direct Fixing



PSU shown

The preferred method of projector mounting. All our PSU mounts are designed to align accurately with the projector mounting holes and take account of cooling or lamp access needs.

All PSU mounts are now available as micro adjustable versions having 2 axis, level & tilt. (See centre panel).

Order Code

- PSU** Standard direct fixing version
- PSC** Cradle direct fixing version
- VSU** Vertical down aspect version
- PPSU** Portrait version
- PSM** Micro-adjustable version

Cradle Units



PSC shown

An alternative method of projector mounting, either to meet a projector's optical needs or to give protection to projectors when used in 'location to location' or hire circumstances.

Micro Adjustment®

This 2 axis micro adjustment factory fitted option is available for most PSU units and provides a range of precision adjustment in level and tilt.



Registered Design

PSU Specials



We have a wealth of expertise in the design and manufacture of all kinds of projector suspension units to meet client's special requirements. These include mounts for downward or upward projection, multi-projector units, 3D rigs and one-off projects.

– Call us when planning your next installation



Trim Disc

Gives a neat finish where columns pass through suspended ceilings.

Order Code

TD1



Retro Trim Disc

Allows fitting after installation for a neat finish.

Order Code

TDRF



Blanking Disc

Blanks holes in ceiling tiles from 6mm to 60mm.

Order Code

TDB1



Photos courtesy of Snelling Business Systems

Guardbox Projector Security Cages

GUARDBOX® Anti-theft Enclosures

Constructed from heavy gauge steel and incorporating many innovative features. Five sizes are available covering a wide range of projectors. Each Guardbox incorporates our unique twin bar system, designed to fit into a number of slots for different projector lens positions. Each bar has another bar fitted inside making it virtually impossible to hacksaw through.



Order Code
PGX

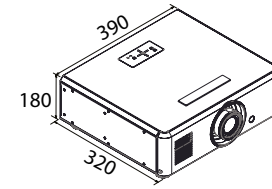

Order Code
PGS

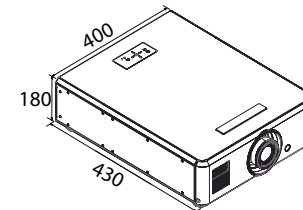

Order Code
PGM

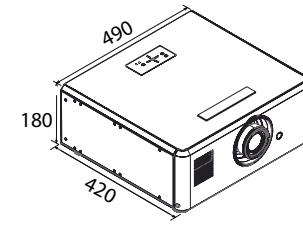

Order Code
PGL

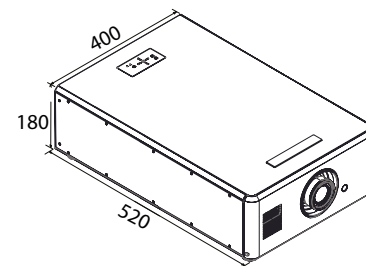

Order Code mm
PGG 560(w) x 620(d) x 250(h)

PGW 600(w) x 550(d) x 250(h)

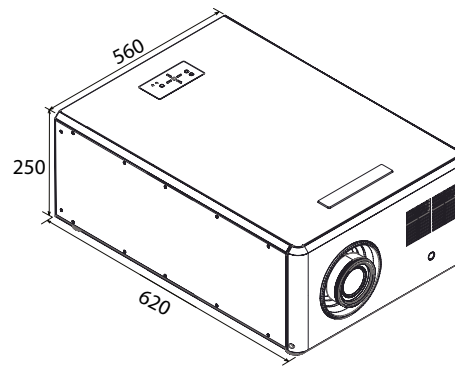

Taglock Kit

As a further aid to security for the Guardbox range, our 'Taglock' Kits are available to provide secondary locking.

Order Code
TLK Comes with padlock



Gyrolock® ~ With Trilok® Docking System

The Trilok docking system uses a standardised 'bayonet style' fitting to carry projector mounting plates made specifically to fit each make & model of projector (a universal version also listed). The docking system allows easy projector set up, removal for routine maintenance and for future model change.

15
Years of
award
winning
design

Over 200,000 sold!



- * Now in white as an option – The GK1 version fits anyway up, ceiling, wall or base fixable
- * Projector locks into Trilok® docking system, using either our dedicated Gyrolock Adapter Plates (GAP) or universal adapter (GAPU)
- * Full tilt & turn adjustment for easy set up
- * Telescopic – for use through suspended ceilings or in any high, low or normal headroom situation
- * Safety rated for projectors up to 20Kg ceiling mounted, 12Kg wall mounted (GK1 only) & 12Kg if using a universal GAP plate (GAPU)



Shown in white as a no cost option. Black as standard

Select any of these versions to suit your headroom needs.

All use the Trilok docking system and are supplied with either a dedicated projector mount (GAP) or optional universal adapter plate (GAPU) if compatible.



Close Ceiling Version

Order Code max weight
GKC-GAP 20kg
(Projector adapter plate version – state projector make & model).

Order Code max weight
GKC-GAPU 12kg
(Universal projector mount version)



Standard Version

Order Code max weight
GK1-GAP 20kg
(Projector adapter plate version – state projector make & model).

Order Code max weight
GK1-GAPU 12kg
(Universal projector mount version)

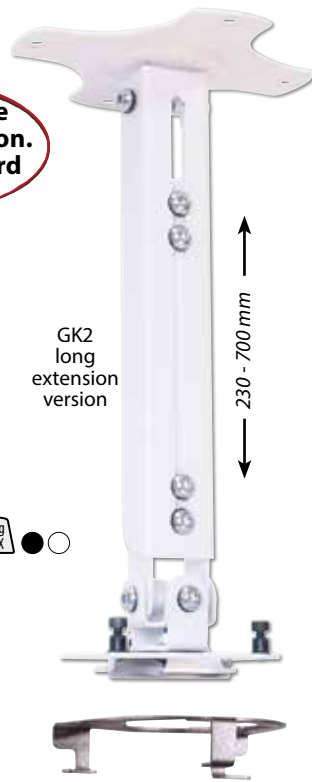

Long Extension Version

Order Code max weight
GK2-GAP 20kg
(Projector adapter plate version – state projector make & model).

Order Code max weight
GK2-GAPU 12kg
(Universal projector mount version)



Column Suspension Version

Gyrolock 'head' complete with adapter plate (or universal mount). Needs column and ceiling plate (see Page 22) to complete your installation.

Order Code max weight
GK4-GAP 20kg
(Projector adapter plate version – state projector make & model).

Order Code max weight
GK4-GAPU 12kg
(Universal projector mount version)



Gyrolock® ~ With Universal Mounts

These products are the subject of UK and USA design rights. UK Registered Design 3011575. UK Trade Mark 2244062. US Patent 10/049390.

These universal mounts offer a wide range of adjustment not only to cover widely differing projector screw fixing centres but also allow clearance for contour variations often found in projector design. A universal screw pack to cover most projectors is included.

Shown in white as a no cost option. Black as standard

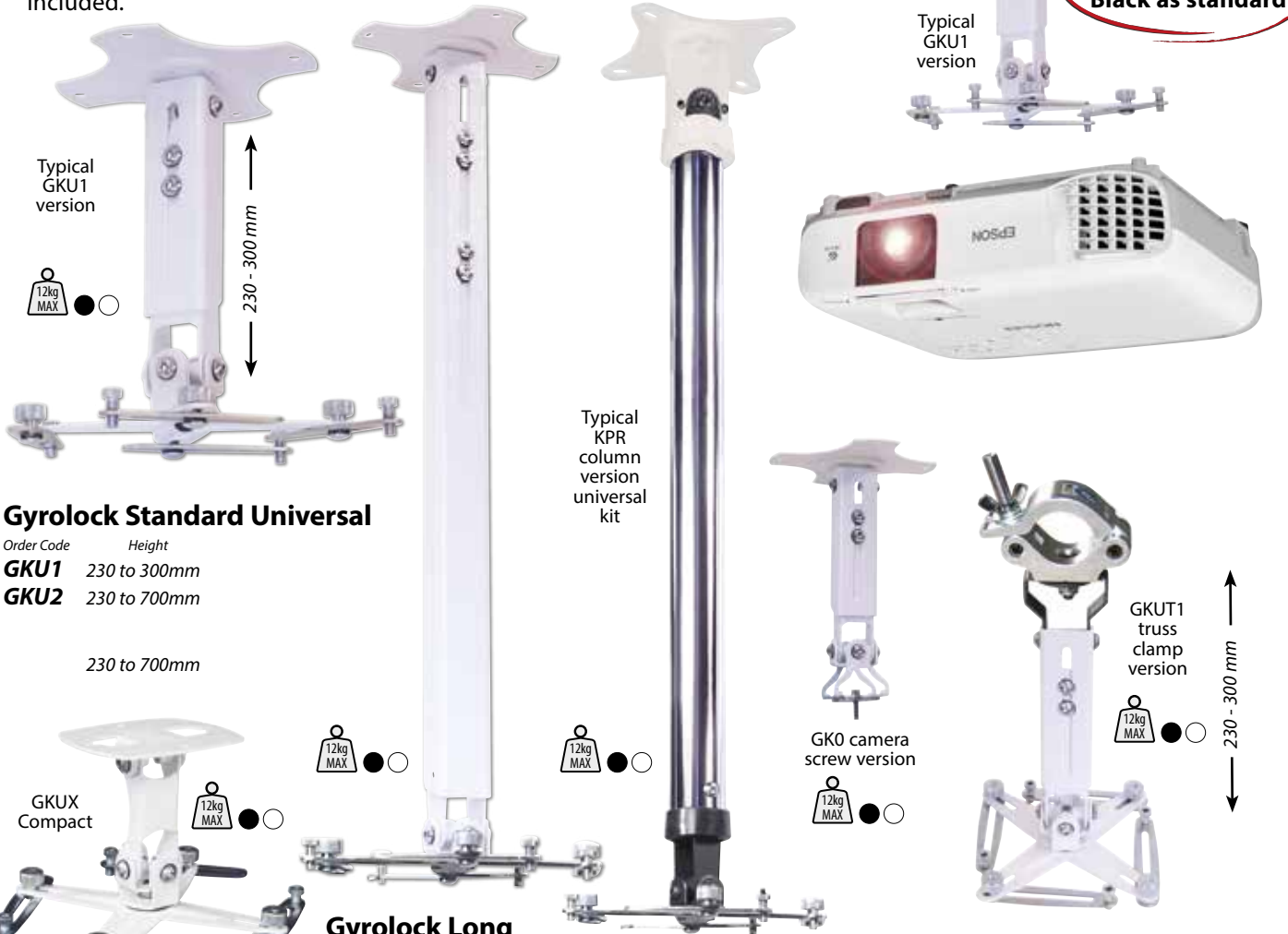

Gyrolock Standard Universal

Order Code	Height
GKU1	230 to 300mm
GKU2	230 to 700mm



Gyrolock Compact

Easy installation
Fixed height

Order Code
GKUX

Gyrolock Long

Adjustable from 700 to 1200mm (suspension only)

Order Code
GKU3
Dedicated GAP version
Order Code
GK3

Column Version Universal Kits

Order Code	Column mm
KPR15CB	500
KPR110CB	1000
KPR120CB	2000
KPR130CB	3000

Truss Clamp Version

Universal mount with standard truss clamp fitting. For all trusses 45 – 55mm dia.

Order Code	Extension mm
GKUT1	230 - 300
GKUT3	700 - 1200

Gyrolock Parts & Accessories



Adapter Plates

Enables changeover whenever replacing projector. State make & model when ordering.

Order Code
GAP 20kg MAX



Universal Adapter Plate

Designed to fit most projectors.

Order Code
GAPU 12kg MAX



Column Suspension Version

Universal mount for direct column connection. See Page 22 for columns & ceiling plates.

Order Code
GKU4 12kg MAX



Gyrolock Trim Disc

Shaped to fit Gyrolock mast. Gives a neat finish to installations through suspended ceilings.

Order Code
GKTD
* For standard column trim discs see page 22.

Single Column Stands & Trolleys

Since 1963 - The original Unicol system of stands & trolleys

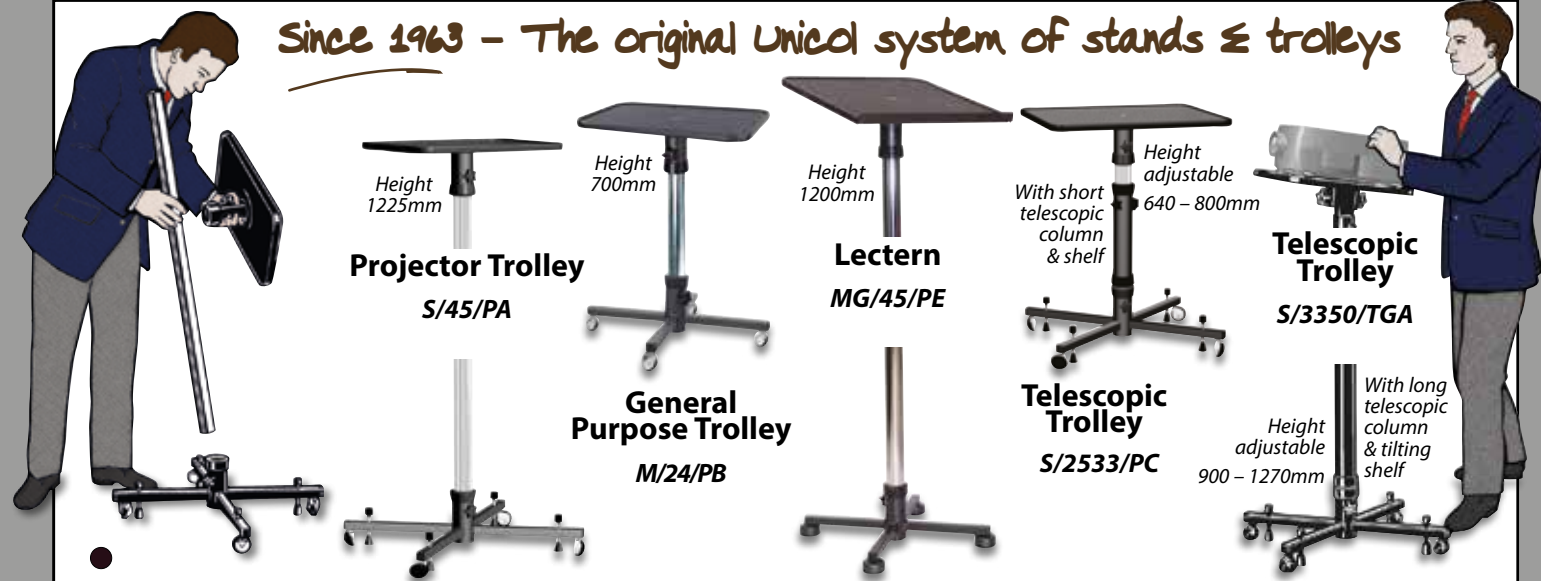

Height 1225mm
Projector Trolley
S/45/PA

Height 700mm
General Purpose Trolley
M/24/PB

Height 1200mm
Lectern
MG/45/PE

Height adjustable 640 - 800mm
With short telescopic column & shelf
Telescopic Trolley
S/2533/PC

Height adjustable 900 - 1270mm
With long telescopic column & tilting shelf
Telescopic Trolley
S/3350/TGA

Platforms
In a range of useful sizes.

Order Code	Size mm
PA	300 x 450
PB	450 x 450
PC	450 x 550

Lectern Platform
Fixed reading angle of 15 degrees.

Order Code	Size mm
PE	450 x 450

Tilting Platforms
Fully adjustable from level to 10 degrees.

Order Code	Size mm
TGA	300 x 450
TGB	450 x 450
TGC	450 x 550

Standard Columns

Order Code	Length
16	410mm
24	610mm
30	760mm
36	900mm
45	1140mm

Also available with longer inner columns
Telescopic Columns

Order Code	Trolley height range
2533	740 to 950mm
3350	840 to 1280mm

Accessory Shelves
Fully height adjustable.

Order Code	Size mm
AP	300 x 300
AD	400 x 400

Bases

Order Code	Size mm
MS	Trolley 400 x 400
MG	Stand 400 x 400

Bases with Jacking Feet

Order Code	Size mm
SS	450 x 550
LS	550 x 650

Other Trolleys

Equipment Trolley
Utility trolley with a great many uses to carry medical, laboratory or test equipment. Other platform sizes listed.

Has heavy base with 10cm rubber tyre castors.
Platform 45x45cm
Trolley Height 75cm

Order Code **T1B/24/PB**

Base unit available as separate purchase.
Order Code **T1B**

Original TC1000 Trolleys
The standard trolley in service with many schools & colleges. Has universal screen mount & equipment shelf. Conversion kit also available for existing trolleys.

Order Code **TC1000**

Conversion kit complete

Gives existing TC1000 trolleys a new lease of life. Conversion kit replaces old style TV mount for modern flat screen use.

Order Code **TCK**

Camera Stands
Superior to tripods for a great many applications. Solid base with braked wheels gives excellent stability.

Fluid effect head
35 - 200cm vertical movement
Studio camera stand

Order Code **CS1000**

Order Code **CS2000**

Parts & Accessories

10cm Castors (Standard - set of 4)
Order Code **C10X4**

10cm Heavy Duty Castors (HD braked - set of 4)
Order Code **BC10X4**

7.5cm Castors (2 plain / 2 braked - set of 4)
Order Code **C074**

5cm Castors (Orbit set of 4)
Order Code **C05X4**

Allen Key
Fits Grub Screws & Through Bolts
Order Code **AK316**

Safety Through-bolt
Order Code **TB38F**

Socket Cap SC
Order Code **SC**

Hand Wheel
Order Code **HW38F**

Grub Screw
Order Code **GS38F**

Replacement Lock & Keys
Order Code **LK**

Spray Paint
Touch in paint in Sinterflex Black / White or Diamond Silver - 400ml cans.
Order Code **SPB** Black
SPW White
SPS Silver

Drilling Jig
Installer's cutting and thro-bolt drilling jig for columns.
Order Code **CDJ1**

Please note: Our 10cm Heavy Duty castors (BC104) are bolt fixed for added strength and to prevent swivel as well as rotation of the wheel, they are intentionally not interchangeable with our 10cm (C104) castors.

Security Devices, Video conference Shelves, Unicol Columns

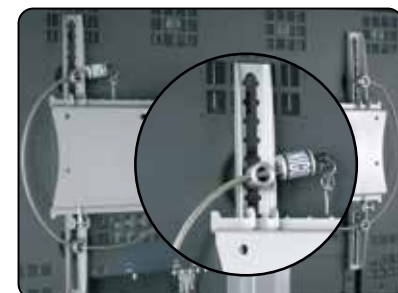

Screen Security Kit
Use this easily fitted Security Kit with any of our mounts.
The 2200mm tough steel cable system has special fittings which shield access to the screen fixing screws.
Order Code **PSK**

Remo Guard™ TV Remote Wall Holders

- * Locks remote to wall
- * Reflects beam to TV or projector

Order Code **RGHW** Standard for most remote Units
RGH1W Custom unit for large remotes

Locking Ceiling Plate
Fits standard CP1 ceiling plate shielding the fixings to deter unauthorised removal.
Order Code **CPSC1**

TETHERLOC® Gyrolock Anti-theft Kit
Tough steel cable system has special fittings which shield access to the projector fixing screws and link the mount and projector to protected ceiling fixing bolts.

Order Code **GT40** for GK1 (40cm cables)
GT80 for GK2 (80cm cables)
GT130 for GK3 (130cm cables)

Video Conference Camera Wall Shelves
Neat units in glass or metal for wall mounting.

Order Code **WBVC** Metal - 350w x 250d
WBVG Glass - size: 500 x 400
WBVG1 Glass - size: 780 x 390

Versions also available for specific video conference cameras and codecs - Call us for details.

Unicol Columns
In standard chrome finish and stainless steel. Also available in colour finishes to special order & unpainted.

In addition to the range of sizes listed we also supply non-standard lengths to special order - Call us for details.

Please note that Safety 'through-bolt' holes must be specified if used for suspension applications.

Standard Chrome Finish		Stainless Steel
Order Code	Length	Order Code
410	410	SS410
500	500	SS500
610	610	SS610
760	760	SS760
900	900	SS900
1000	1000	SS1000
1140	1140	SS1140
1500	1500	SS1500
2000	2000	SS2000
3000	3000	SS3000

List above indicates traditional imperial and metric lengths

UNICOL[®]

Supporting You



AV Mounts - for the professionals

UNICOL Green Road Oxford OX3 8EU 01865 767676 sales@unicol.com www.unicol.com

